



# Wayfinding and Perception Abilities for Pedestrian Simulations

Erik Andresen

IAS Series

Band / Volume 38

ISBN 978-3-95806-375-4







Forschungszentrum Jülich GmbH  
Institute for Advanced Simulation (IAS)  
Civil Safety Research (IAS-7)

# **Wayfinding and Perception Abilities for Pedestrian Simulations**

Erik Andresen

Schriften des Forschungszentrums Jülich  
Reihe IAS

Band / Volume 38

---

ISSN 1868-8489

ISBN 978-3-95806-375-4

Bibliografische Information der Deutschen Nationalbibliothek.  
Die Deutsche Nationalbibliothek verzeichnet diese Publikation in der  
Deutschen Nationalbibliografie; detaillierte Bibliografische Daten  
sind im Internet über <http://dnb.d-nb.de> abrufbar.

Herausgeber und Vertrieb: Forschungszentrum Jülich GmbH  
Zentralbibliothek, Verlag  
52425 Jülich  
Tel.: +49 2461 61-5368  
Fax: +49 2461 61-6103  
zb-publikation@fz-juelich.de  
[www.fz-juelich.de/zb](http://www.fz-juelich.de/zb)

Umschlaggestaltung: Grafische Medien, Forschungszentrum Jülich GmbH

Titelbild: ©adisa – stock.adobe.com

Druck: Grafische Medien, Forschungszentrum Jülich GmbH

Copyright: Forschungszentrum Jülich 2018

Schriften des Forschungszentrums Jülich  
Reihe IAS, Band / Volume 38

D 468 (Diss., Wuppertal, Univ., 2018)

ISSN 1868-8489  
ISBN 978-3-95806-375-4

Persistent Identifier: [urn:nbn:de:0001-2018121810](https://nbn-resolving.org/urn:nbn:de:0001-2018121810)

The complete volume is freely available on the Internet on the Jülicher Open Access Server (JuSER)  
at [www.fz-juelich.de/zb/openaccess](http://www.fz-juelich.de/zb/openaccess)



This is an Open Access publication distributed under the terms of the [Creative Commons Attribution License 4.0](https://creativecommons.org/licenses/by/4.0/),  
which permits unrestricted use, distribution, and reproduction in any medium, provided the original work is properly cited.

# Nomenclature

<b>Abbreviation</b>	<b>Description</b>
JPS / JuPedSim	Jülich Pedestrian Simulator
JPScore	Calculating engine of JuPedSim
AI	Artificial Intelligence
SP	Shortest path algorithm
Rd.	Random choice model
NDH	Nearest room/door heuristic
CMap	Cognitive map model
VR	Virtual reality
HMD	Head mounted display
SP (Ch. 9)	Starting point
DP	Decision point
Conc.	Concourse level
Stc.	Staircase
KD	Knowledge degree
Fam.	Familiar
Col.	Collaboration
TTO	Travel time optimization





---

Notation	Description	Unit
$m_i$	Mass of pedestrian $i$	kg
$\vec{x}_i$	Position of pedestrian $i$	m
$\vec{F}_i$	Force acting on pedestrian $i$	N
$F_i^{drv}$	Driving force acting on pedestrian $i$	N
$F_{ij}^{rep,p}$	Repulsive force between pedestrians $i$ and $j$	N
$F_{ij}^{rep,w}$	Repulsive force between pedestrian $i$ and wall $j$	N
$N_i$	Subset of pedestrians that influence pedestrian $i$	-
$W_i$	Subset of walls that influence pedestrian $i$	-
$\Delta t$	Time interval between updates of isovists	s
$C$	Crossing to unexplored area	-
$C_v$	Visible crossing	-
$d_i$ (Ch. 3)	Distance between the visible crossing $C_{v,i}$ and a selected crossing to unexplored area	m
$\vec{PL}$	Line segment from the agent's position to the nearest point on the ellipse that represents the landmark's position	m
$\vec{PC}_i$	The line segment from the agent's position to the center point representing crossing to unexplored area $C_i$	m
$\alpha_i$	Angle between the line segment $\vec{PL}$ from the agent's position to the nearest point on the ellipse that represents the landmark's position and the line segment $\vec{PC}_i$ from the agent's position to the center point representing crossing to unexplored area $C_i$	rad
$\alpha_{min}$	The smallest angle of all angles $\alpha$	rad
$P$	Parameter that describes the general probability that signage is detected	-
$P_i$	Probability that pedestrian $i$ perceives sign $S_i$	-
$P_0$ (Ch. 5)	Probability that the first visible sign is perceived by an agent	-
$m$	Number of consecutive signs that have been detected by an agent	-
$n$	Number of consecutive signs that have been ignored by an agent	-

---

Notation	Description	Unit
$\zeta$	Model parameter that describes the increase of the probability to detect signs if previous signs have been perceived	-
$\eta$	Model parameter that describes the decrease of the probability to detect signs if previous signs have been ignored	-
$d_i$ (Ch. 5)	The shortest distance from the center of crossing $C_i$ to the vector (straight line) that represents the direction indicated on the sign	m
$\vec{S}_R$ ( $\vec{S}_{iR}$ )	The vector that represents the direction indicated on the sign (i)	m
$\vec{S}C_i$	The vector that connects the sign's center and the center of crossing $C_i$ .	m
$\beta_i$	The angle between the vector that represents the direction indicated on the sign and the vector that connects the sign's center and the center of crossing $C_i$ .	rad
$\vec{S}_i\vec{S}_j$	The vector that connects the positions of signs 2 and 1.	m
$\gamma_{i,j}$	The angle between the vector that represents the direction of the instruction on sign $i$ and the vector that connects the position of signs $i$ and $j$ .	rad
$\gamma_{i,min}$	The smallest angle of all angles $\gamma$ that are related to sign $i$	rad
$P(k)$	Probability that a certain landmark is part of the regarded cognitive map	-
$k$	Self-rated knowledge degree	-
$m/P_0$ (Ch. 7)	Parameters of the linear equation that describes the relation between self-rated knowledge degree $k$ and the probability $P(k)$ that a certain landmark is preserved	-
$\bar{dev}_{min}$	Lowest average deviation between the route usage observed in the study and predicted by the model	-

# Abstract

Computer simulations of pedestrian dynamics are common and reliable tools in order to evaluate safety risks of facilities. However, still many software frameworks for evacuation simulations imply the assumption that all simulated pedestrians are familiar with their environment and therefore take the shortest path to the outside. In fact, the spatial knowledge of people generally varies. Thus, the assumption that all persons of a building possess comprehensive spatial knowledge is a rough approximation of the reality. Especially for simulations in complex buildings the reliability of this approximation is questionable.

In order to make simulations of pedestrian dynamics more reliable in this regard, this thesis introduces a new software framework. This framework provides the possibility to predict route choices of a group of people with varying spatial knowledge degrees. Therefore, the framework also considers selected wayfinding strategies that are applied beside the use of spatial memories. These are using signage, using generalized knowledge about the structure of buildings, and search strategies.

In addition, three studies have been conducted in order to investigate wayfinding abilities and strategies of people in office buildings and subway stations. The results of the studies are discussed and are used to calibrate and test the models of the new software framework.

Finally, the framework is applied to conduct a case study of an evacuation scenario in a subway station. The case study turns out that the egress time in the station is strongly dependent on the wayfinding strategies and abilities of the occupants. This outcome suggests that the proper consideration and prediction of route choices is relevant and necessary for reliable evacuation simulations.

# Kurzfassung

Computersimulationen von Fußgängerströmen sind heutzutage ein gängiges Hilfsmittel, wenn es darum geht, Sicherheitsrisiken eines geplanten Neubaus oder Bestandsobjektes im Vorfeld zu erkennen und zu analysieren.

Die Mehrheit der Modelle für die Routenwahl von Fußgängern legt die Annahme zugrunde, dass Menschen sich für einen Weg entscheiden, deren zurückzulegende Strecke möglichst kurz ist oder deren Reisezeit möglichst klein ist. Dies impliziert, dass sämtliche Räume, Ausgänge, Korridore, etc. jedem Fußgänger bekannt sind. Diese Annahme kann im Besonderen bei der Betrachtung von komplexen Gebäuden nur als starke Vereinfachung der menschlichen Orientierung bzw. Wegfindung angesehen werden. Um Evakuierungssimulation diesbezüglich zu verbessern bzw. belastbarer zu machen, stellt die vorliegende Thesis ein neues Software-Framework vor. Dieses bietet die Möglichkeit, auch Fußgänger bzw. deren Routenwahl abzubilden, die nur Teile des Gebäudes kennen oder denen das Gebäude unbekannt ist. Die Modelle des Frameworks berücksichtigen hierbei die Anwendung von räumlichem Wissen (kognitive Karte), die Nutzung der Fluchtwegsbeschilderung und die Verwendung von generalisiertem Wissen über Gebäudestrukturen.

Des Weiteren wurden drei Studien zur Untersuchung der Wegewahl von Personen in Bürogebäuden und U-Bahnhöfen durchgeführt. Die Ergebnisse der Studien werden in dieser Thesis diskutiert und zur Kalibrierung und Prüfung der Modelle herangezogen.

Schließlich wird das Framework im Rahmen einer Simulationsstudie in einer U-Bahnstation angewendet. Diese Studie zeigt, dass die Räumungszeit der Station in Abhängigkeit der Wegfindungsstrategien und -fähigkeiten der Personen stark variieren kann und daher die Berücksichtigung menschlicher Wegfindung in Evakuierungssimulationen relevant ist.

# Contents

<b>I</b>	<b>Introduction</b>	<b>1</b>
<b>1</b>	<b>Simulation of Pedestrian Dynamics</b>	<b>3</b>
1.1	Motivation and Application . . . . .	3
1.2	Models . . . . .	4
1.2.1	Operational Models . . . . .	5
1.2.2	Tactical Level - Route Choice Models . . . . .	7
1.3	Thesis Motivation, Objective and Outline . . . . .	11
<b>2</b>	<b>Human Navigation</b>	<b>15</b>
2.1	Navigation - locomotion and wayfinding . . . . .	15
2.2	The cognitive map . . . . .	16
2.3	Landmarks and further items of the cognitive map . . . . .	17
2.4	Wayfinding - Procedures and tools . . . . .	19
2.4.1	Spatial memories - Cognitive maps vs. action-based representations . . . . .	19
2.4.2	External aid or information . . . . .	20
2.4.3	Generalized knowledge . . . . .	22
2.5	New taxonomy of wayfinding tasks in evacuations . . . . .	23
2.6	Discussion . . . . .	24
<b>II</b>	<b>Modeling Cognitive and Perceptual Abilities for Wayfinding</b>	<b>27</b>
<b>3</b>	<b>General properties of the software framework</b>	<b>29</b>
3.1	Miscellaneous . . . . .	29
3.2	Perceptual abilities . . . . .	30
3.3	Short term memories . . . . .	31
3.4	Selecting an appropriate visible target . . . . .	31



3.5	Restrictions to the selection of crossings - benefit rule . . . . .	33
3.6	Exploration and search strategies . . . . .	33
3.7	Summation and discussion . . . . .	35
<b>4</b>	<b>Spatial knowledge - A cognitive map approach</b>	<b>39</b>
4.1	Modeling cognitive map representations . . . . .	39
4.1.1	Evaluation of the cognitive map . . . . .	41
4.1.2	Path searching to landmark . . . . .	44
4.1.3	Modeling action-based representations (route knowledge) . . . .	46
4.2	Implementation of generalized knowledge . . . . .	48
4.2.1	Examples . . . . .	50
4.3	Summation and discussion . . . . .	51
<b>5</b>	<b>Perception of signs</b>	<b>53</b>
5.1	Miscellaneous . . . . .	53
5.2	Visibility of signs . . . . .	53
5.3	Probability to detect signage . . . . .	55
5.4	Implementing a sign's instruction . . . . .	56
5.5	Example . . . . .	59
5.6	Summary and discussion . . . . .	61
<b>6</b>	<b>Summarizing the cognitive framework</b>	<b>63</b>
6.1	Combination of single parts . . . . .	63
6.2	Implementation . . . . .	65
<b>III</b>	<b>Experiments and Model Calibration</b>	<b>69</b>
<b>7</b>	<b>Wayfinding studies in an office building</b>	<b>71</b>
7.1	Miscellaneous . . . . .	71
7.2	Method . . . . .	71
7.2.1	Participants . . . . .	71
7.2.2	Task . . . . .	72
7.3	Results . . . . .	75
7.4	Calibration by comparing route distributions from field study and sim- ulations . . . . .	76
7.5	Summary and discussion . . . . .	83

<b>8</b>	<b>Wayfinding studies in a subway station</b>	<b>85</b>
8.1	Miscellaneous . . . . .	85
8.2	Method . . . . .	85
8.2.1	The subway station . . . . .	86
8.2.2	Participants . . . . .	88
8.2.3	Experimental procedure . . . . .	89
8.3	Results . . . . .	93
8.3.1	Real study . . . . .	94
8.3.1.1	Decision point 1 . . . . .	94
8.3.1.2	Decision point 2 . . . . .	97
8.3.1.3	Decision point 3 . . . . .	99
8.3.2	VR-Study . . . . .	100
8.3.2.1	Decision point 1 . . . . .	100
8.3.2.2	Decision point 2 . . . . .	102
8.3.2.3	Decision point 3 . . . . .	102
8.3.3	Overall sign perception and usage - Real and VR-study . . . . .	103
8.4	Discussion - Differences between real and VR-study . . . . .	104
8.5	Summary and Conclusions . . . . .	105
8.6	Model calibration . . . . .	106
8.6.1	Generalized knowledge . . . . .	106
8.6.2	Sign usage . . . . .	106
8.6.3	Reproducing the field study's route choice distribution at DP1 . . . . .	108
8.6.4	Discussion . . . . .	108
<b>IV</b>	<b>Case Study</b>	<b>109</b>
<b>9</b>	<b>Application to an evacuation of a subway station</b>	<b>111</b>
9.1	Miscellaneous . . . . .	111
9.2	The station (simulation geometry) . . . . .	111
9.3	Initial conditions . . . . .	114
9.4	Route choice models . . . . .	115
9.5	Results . . . . .	116
9.5.1	Overall egress times . . . . .	116
9.5.2	Investigation of selected flows at staircases and exits . . . . .	119
9.6	Summary and discussion . . . . .	124

<b>V</b>	<b>Conclusion and Outlook</b>	<b>127</b>
<b>10</b>	<b>Closing Remarks</b>	<b>129</b>
10.1	Summary and conclusions . . . . .	129
10.2	Outlook . . . . .	132
<b>VI</b>	<b>Appendices</b>	<b>135</b>
Appendix A	Route distribution that resulted from the cognitive map model	137
Appendix B	Case study - Used geometry	138
Appendix C	Case study - Initial conditions	140
References		149

# List of Figures

1.1	Rock am Ring. Annual large-scale music festival in Germany with ca.80000 visitors. A major challenge for organizers and security officers. Source: Lawen, Andreas [2017] . . . . .	4
1.2	a) Agents of a Cellular Automata moving from cell to cell to reach the exit. b) The three forces that affect the physical movement of an agent in a force-based model. The forces are exemplarily shown for one agent (and one neighbor). . . . .	6
2.1	Possible mental representation of a person’s workplace. . . . .	18
2.2	A wayfinding taxonomy showing tools and strategies which are used to solve wayfinding tasks in evacuation situations. The taxonomy is based on a taxonomy by Wiener et al. [2009]. . . . .	24
3.1	a) The filled violet polygon describes the visible area (isovist) from the agent’s current position. Blues lines depict possible crossings to proceed. Possible crossings are represented by their centers (orange) to facilitate calculations. b) The filled violet polygon describes the visible area (isovist) of the agent. The union of the blue and violet polygon describes the area which the agent has already seen during its travel. . . . .	30
3.2	a) The environment that the agent has already explored is marked blue, the area that is currently visible is marked violet. The agent can choose between four visible crossings ( $C_{v,1}$ - $C_{v,4}$ ) (green) to proceed to the previously selected crossing to unexplored area $C$ (orange). The euclidean distance $d_1$ between the visible crossing $C_{v,1}$ and the crossing to unexplored terrain $C$ is marked red. . . . .	32

3.3	Procedure 1: Restrictions to the selection of crossings - The benefit rule. A new crossing is only selected if it provides a remarkable benefit in comparison to the crossing which has been chosen in the previous step. The procedure applies for both visible crossings and crossings to unexplored area. In terms of the selection of a visible crossing a candidate provides a remarkable benefit if the respective distance $d_i$ to the previously selected crossing to unexplored area is remarkably lower (suggestion: 25 %). For more information about the benefit rule in the context of the selection of a crossing to unexplored area see Sec.4.1.2. . . . . .	34
3.4	Trajectories (blue) of an agent applying the nearest door heuristic to find the outside in an office facility. . . . .	35
3.5	Procedure 2: Procedure to identify crossings in the visible area that are possibilities to proceed to an exit and to select one of them that serves best to reach the outside efficiently. . . . .	37
4.1	Representation of landmarks (here stairs) in a modeled cognitive map. The ellipses depicts the inaccuracy of the knowledge about the positions of landmarks. . . . .	40
4.2	Representation of landmarks in a cognitive map. The ellipses depict the inaccuracy of the knowledge about the landmarks' positions. Thin arrows mark connections between landmarks. . . . .	41
4.3	In the background: Spatial structure of a fictional office layout. In the foreground: A conceivable cognitive map of the structure in the background. The ellipses represent the inaccurate idea about the landmarks' positions within the map. The arrows depict connections between the landmarks. The stars mark the real landmarks' positions. . . . .	42
4.4	Procedure 3: The figure shows the algorithm which is used to evaluate the items in the cognitive map and to determine a suitable subdestination (landmark). The algorithm is executed every time an agent's isovist has been updated. . . . .	43
4.5	Angle $\alpha_i$ between the line segment $\vec{P}\vec{L}$ from the agent's position to the nearest point on the ellipse and the line segment $\vec{P}\vec{C}_i$ from the agent's position and the center point representing the crossing to unexplored area $C_i$ . The angle $\alpha_3$ is exemplary depicted. . . . .	45



LIST OF FIGURES

---

4.6 a)/ b) Possible current states of route knowledge always incorporating two connected landmarks. . . . . 46

4.7 Procedure 4: Modeling route knowledge: This algorithm ensures that agents are provided with a new memory indicating the next step on their route if they have reached an intermediate destination. If there are no further destinations in the destination, the agent has completed its route. . . . . 47

4.8 Procedure 5: Beforehand, the list of identified crossings to unexplored area is shuffled if agents are supposed to apply random choices as their search strategy. Alternatively, the nearest door heuristic (NDH) can be used as the search strategy. Subsequently, the list of crossings to unknown area is sorted under consideration of information from the cognitive map (see Sec.4.1.2). Then, it is sorted again considering generalized knowledge. For this purpose, each of the crossings is inserted in the list that corresponds to the room type in which the crossing is located. Subsequently, the individual lists are put together. The above shown hierarchy of room types is taken into account. Consequently, exits (if present) are the first elements in the concatenated list, then lobbies (if present), than stairs (if present), etc.. 49

4.9 Trajectories of an agent starting in the left lower corner and trying to find the exit. a) The agent possesses a single clue in its cognitive map. b) The agent possesses a single clue in its cognitive map and knows about the function of circulation rooms. . . . . 50

5.1 a) British exit signage that was used in the study by Xie et al. [2007]. From top to bottom: Sign1, Sign2, Sign3 b) Average viewing distance in dependency on the observation angle at which participants in the study by Xie et al. [2007] still were able to identify exit signage shown in a). . . . . 54

5.2 An agent is approaching a T-junction at which a sign has been installed. Three crossings to proceed ( $C_1, C_2, C_3$ ) are available. They are represented by their centers.  $\beta_2$  describes the angle between the vector  $\vec{S}_R$  that represents the direction indicated on the sign and the vector  $\vec{SC}_2$  that connects the sign's center and the center of crossing  $C_2$ .  $d_3$  describes the shortest distance from the center of crossing  $C_3$  to the vector  $\vec{S}_R$ . . . . . 56

---

5.3	An agent is approaching a T-junction. Three signs are visible from the agent's current position. $\gamma_{2,1}$ describes the angle between the vector $\vec{S}_{2R}$ that represents the direction of the instruction on Sign 2 and the vector $S_2\vec{S}_1$ that connects the positions of signs 2 and 1. . . . .	58
5.4	A small, fictional maze. The agent tries to find a way to the exit which is located at the upper right corner. Two exit signs are present at the two decision points. . . . .	59
5.5	a) Route distribution of Scenario A. b) Route distribution of Scenario B.	60
5.6	Procedure 6: Procedure to find the crossing to unknown area that serves best to follow the instruction on a perceived sign. . . . .	62
6.1	Procedure 7: Procedure of the combined model framework. First a crossing to unknown area is selected under consideration of the cognitive map, exit signage and generalized knowledge. Subsequently, a visible crossing is identified that serves best to reach the previously chosen crossing to unknown area. . . . .	64
6.2	Interaction of the involved classes in the entire model framework. . .	66
6.3	Class relations of classes that are part of the JPS-AI-Framework and their connections to classes of JuPedSim. . . . .	67
7.1	In the background: The floor plan of the area which was used for the field study. In the foreground: All possible routes the subjects could use. . . . .	73
7.2	a) View from the starting point towards the corridor on the right side of the floor plan. b) Crossing that leads to Stair D. c) Crossing that leads to Balcony B. . . . .	74
7.3	In the background: The floor plan of the area which was used for the simulation cases. Red lines depict final exits. In the foreground: Landmarks and main destinations that are incorporated in a cognitive map that represents comprehensive spatial knowledge. . . . .	78
7.4	Relation between knowledge degree $k$ of an agent and probability $P(k)$ that a landmark or main destination is incorporated in its cognitive map. a) All landmarks and main destination are treated equally. b) The probability (green dashed line) that landmarks A, B, D, G and main destinations A and B are preserved is twice as high in comparison to the probability of other landmarks or main destinations (blue line). . . . .	83

## LIST OF FIGURES

---

8.1	Isometric view of the complete subway station in which the here discussed studies took place. . . . .	86
8.2	a) Yellow-black exit signage present at walls and ceilings in the station. Ausgang is the german word for exit. b) Green-white emergency exit signage installed at the bottom of walls and pillars in the station. . .	87
8.3	Real underground station. View from Decision point 1 (DP1) (see Fig.8.1) towards both stairs U8.1 and U8.2 (left: leading to the concourse level; right: leading to U9). . . . .	90
8.4	Real underground station. View from Starting point 2 (SP2) on the stair that connects the platforms U8 and U9. . . . .	90
8.5	Real underground station. Participant is approaching DP3. . . . .	91
8.6	Virtual underground station. Coming from SP1 a participant is approaching DP1. Figure does not correspond to the field of view of the subject. . . . .	92
8.7	Virtual underground station. View from SP2 on Staircase U8.2 that connects platforms U8 and U9. Figure does not correspond to the field of view of the subject. . . . .	92
8.8	Virtual underground station. Participant is approaching DP3. Figure does not correspond to the field of view of the subject. . . . .	93
8.9	Topdown view on parts of Platform U8 around SP1 and DP1. Position of exit signage is marked. Additionally, this figure shows the route choice distribution at DP1 among the participants of the real study. . . . .	94
8.10	Topdown view on parts of Platform U9 around SP2/DP2. Position of exit signage is marked. Additionally, this figure shows the route choice distribution of the real study's participants at DP2. . . . .	98
8.11	Route choice distribution at DP3 in the real study. . . . .	100
8.12	Route choice distribution at DP1 in the VR-study of both signage and no-signage (in brackets) group. . . . .	101
8.13	Route choice distribution at DP2 in the VR-study of both signage and no-signage (in brackets) group. . . . .	102
8.14	Route choice distribution at DP3 in the VR-study. . . . .	103
9.1	Isometric view of the subway station that is the subject of this case study. . . . .	112
9.2	The positions of yellow-black exit signs on platforms U8 and U9. . .	113
9.3	The positions of yellow-black exit signs on the concourse level. . . .	114

9.4	Distributions of egress times in the subway station under consideration of various route choice models. . . . .	117
9.5	Course of the flow at the feet of the four staircases on Platform U8. a) Staircase U8.1 b) Staircase U8.2; The flows at the two stairs that belong to Staircase U8.2 are summed. c) Staircase U8.3 . . . . .	120
9.6	Course of the flow at the feet of the two staircases on Platform U9. a) Staircase U9.1 b) Staircase U9.3 . . . . .	121
9.7	Course of the flow at the exits on the concourse level. a) Exit A b) Exit B c) Exit C d) Exit D e) Exit E . . . . .	123
B.1	The simplified floor plan of the subway station's concourse level that has been used in the context of the case study discussed in Chapter 9.	138
B.2	The simplified floor plan of Platform U9 that has been used in the context of the case study discussed in Chapter 9. . . . .	139
B.3	The simplified floor plan of Platform U8 that has been used in the context of the case study discussed in Chapter 9. . . . .	139

**Part I**  
**Introduction**



---

# Chapter 1

## Simulation of Pedestrian Dynamics

### 1.1 Motivation and Application

In the last decades the world wide population in urban environments has been increasing severely. In the year 2030 the world wide percentage of people living in agglomerations will have doubled in comparison to 1950 [Hedda Nier, 2017]. In addition, the proportion of employees who are commuters has been increasing in the recent years. Now, the percentage of commuters already exceeds 50 % in various german cities [UN DESA, 2014]. At the same time large-scale events became more and more popular.

These trends are accompanied by new major challenges for urban planners, designers and organizers in order to ascertain moving urban traffic and to avoid congestion and overcrowding. Facing these complex challenges computer simulations of movements of individual pedestrians or crowds of pedestrians are used more frequently by responsible persons.

Simulations are not only applied to evaluate escape routes in facilities but also to design pedestrian areas in city centers, malls, traffic stations, and airports. Nowadays, they are common tools in order to detect and assess safety risks in a planned new construction or an existing property. In advance, simulations provide detailed information about the pedestrian flow at each location within the facility. For instance, it is possible to detect high densities in a narrow corridor or to identify platforms in a subway station which are temporarily overloaded. Simulations are used to investigate both evacuation processes and daily traffic phenomena. They are applied to ensure the occupants' safety in various indoor facilities of any size and also in the context of outdoor events e.g. music festivals (see Fig. 1.1).

In addition, pedestrian crowd simulations help to understand the underlying reasons for the occurrence of overcrowding and high occupant densities. Consequently,



Figure 1.1: Rock am Ring. Annual large-scale music festival in Germany with ca. 80000 visitors. A major challenge for organizers and security officers. Source: Lawen, Andreas [2017]

they provide the possibility to counteract crowd disasters e.g. Love Parade 2010 [Stolowsky et al., 2010], Phnom Penh 2010 [CNN Wire Staff, 2017], Moscow 2010 [Buribayev, Aydar, 2010], Mekka 2015 [Reuters, 2015], London 2017 [Griffin, 2017].

## 1.2 Models

A computer simulation is the application of a mathematical or rule-based model. In general, models consist of a set of rules or equations that describe coherences, phenomena or dynamics of an event. In terms of the modeling of pedestrian movements a distinction is made between modeling the operational and the tactical level. The operational level considers the physical movement of persons to a determined visible target. This comprises moving in free space, leaving space to walls, steering around obstacles, and possibly interacting with other pedestrians.

Generally, the pedestrians' final destination is not in sight from the starting point of their travel. Hence, routes, possibly via subgoals, have to be planned to reach the final destination. The tactical level comprises the pedestrians' route planning or rather route choice decisions.

### 1.2.1 Operational Models

In principle, there are two types of models that are put into practice in order to predict the operational movement or rather the interaction of pedestrians. On the one hand, there are macroscopic models which describe a crowd and their properties, for instance its speed and density, as a single entity. Partially, they have been developed following rules of fluid dynamics. Predtechenskii and Milinskii [1978] have to be named among those who introduced the first macroscopic models to predict pedestrian traffic. Due to the reduced complexity it has been possible to apply these models by hand. Consequently, they were commonly used at times when computers were not prevalent or not sufficiently powerful. However, the original and more elaborated macroscopic models which are partially implemented as a computer program are still popular and applied in specific situations. For a first overview about macroscopic models see [Kormanová et al., 2014; Twarogowska et al., 2014].

On the other hand, there are microscopic models. In contrast to their macroscopic counterparts these models consider each pedestrian as an individual. Consequently, every modeled pedestrian (called agent) can be provided with individual properties or rather parameters e.g. its desired speed. Thus, it is possible to model heterogeneous groups of pedestrians and to identify fluctuations and differences within the groups, for example in terms of their densities. In principle, microscopic models are accompanied with an increased amount of computational effort. Some models consist of a system of coupled differential equations (an equation for each of the pedestrians). This system can only be solved numerically and therefore practically only with the help of a computer.

Cellular Automata belong to the group of microscopic models. Here, the agents move on discrete cells with a specific size (commonly 40 cm) by predetermined, partially probabilistic, rules (see Fig. 1.2(a)). In principle, Cellular Automatas require a small amount of computational effort in comparison to other microscopic approaches. It is therefore possible to simulate large-scale scenarios in short time with current desktop hardware. However, the discretization of the room is accompanied by disadvantages in terms of the representation of the structure of a building which decreases the accuracy of the simulation. For more information about Cellular Automatas see for example [Blue and Adler, 2001; Kirchner and Schadschneider, 2002; Nishinari et al., 2004; Kretz and Schreckenberg, 2006].

In contrast, space continuous models allow agents, as the name already suggests, to move in continuous space. Force-based models are prevalent among these. One of the first force-based model was introduced by Hirai and Tarui [1977]. Since then, many

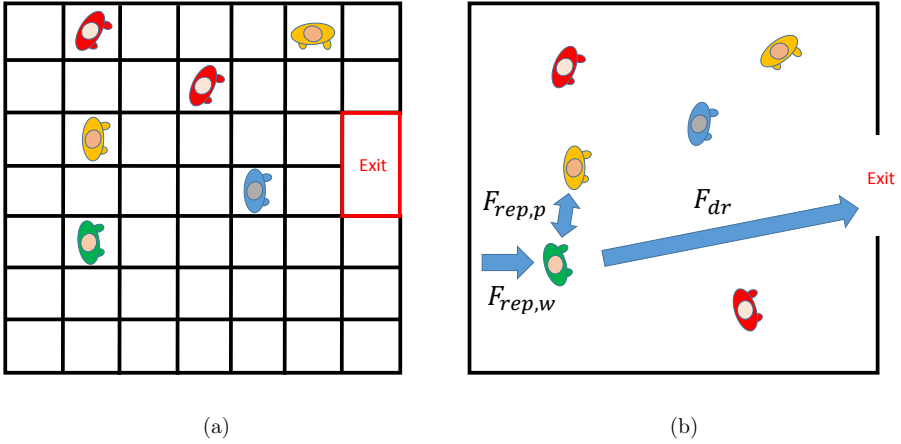

Figure 1.2: a) Agents of a Cellular Automata moving from cell to cell to reach the exit. b) The three forces that affect the physical movement of an agent in a force-based model. The forces are exemplarily shown for one agent (and one neighbor).

modifications, extensions and improvements of this and other early models have been published. However, the principle is still the same: It is assumed that the physical movement is affected by three forces (see Eq. 1.1 and Fig. 1.2(b)). The first force represents a pedestrian's willingness to reach his/her destination. In consequence, it is an attractive force driving the agent towards the destination. The second force is a repulsive force between the agents and makes them keep distance to each other. The remaining force ensures that the simulated pedestrians keep sufficient distance to walls. For each of the agents the superposition of these forces equals the total force that affects the agent. The total force equals pedestrian's mass  $m_i$  times pedestrian's acceleration  $a_i$  which is the second time derivative of its spatial position:

$$m_i \cdot \ddot{\vec{x}}_i = m_i \cdot \vec{a}_i = \vec{F}_i = F_i^{\vec{d}rv} + \sum_{j \in N_i} F_{ij}^{\vec{r}ep,p} + \sum_{w \in W_i} F_{iw}^{\vec{r}ep,w} \quad (1.1)$$

Here,  $N_i$  describes the subset of pedestrians that influence pedestrian  $i$ .  $W_i$  is the subset of walls and obstacles that affect pedestrian  $i$ . Pooling the equations for each agent results in a system of coupled differential equations which can be solved numerically. For information about further force-based models see for example Chraïbi et al. [2013] (brief overview) or Helbing and Molnár [1995]; Yu et al. [2005]; Kretz et al. [2008]; Parisi et al. [2009]; Chraïbi et al. [2010]; Seyfried et al. [2011].

Beside force-based models, there are space continuous approaches that determine the agents' velocities directly instead of their accelerations e.g. Nakayama et al. [2005]; Tordeux et al. [2016]. Since the velocity is the first time derivative of the spatial position, only one numerical integration step is necessary here. This fact comes along with some advantages in terms of numerical stability.

Furthermore, rule-based models e.g. Thompson and Marchant [1995], models based on Voronoi cells e.g. Xiao et al. [2016], and models that consider anticipatory intelligence (collision avoidance models) e.g. Karamouzas et al. [2009]; Asano et al. [2010]; Karamouzas et al. [2017] are present in the literature.

### **Experiments and model validation**

The modeling of pedestrian movement is only a part of the investigation of operational pedestrian dynamics. The other major part is the execution and analysis of field studies and studies in controlled environments. Without knowledge derived from studies models cannot be tested, calibrated, validated or improved. At worst, they even cannot be developed at all (applies particularly for empirical models).

Beside the validation of models, experiments generally are crucial to understand basic dynamics and complex phenomena of pedestrian dynamics. Various studies can be found in the literature, for example simple single-file motion experiments e.g. Chattaraj et al. [2009]; Ziemer et al. [2016]; Cao et al. [2016]; Sun et al. [2018], studies of pedestrians moving through corridors and bottlenecks unidirectionally and bidirectionally e.g. Hoogendoorn et al. [2005]; Kretz and Schreckenberg [2006]; Seyfried et al. [2010]; Liu et al. [2014], controlled studies of more complex scenarios such as multidirectional traffic at junctions, and field observations in large facilities such as stadiums e.g. Kemloh Wagoum, Armel Ulrich [2013]; Burghardt [2013]. For an overview about various studies about pedestrian dynamics see Shi et al. [2015].

## **1.2.2 Tactical Level - Route Choice Models**

### **Travel distance and travel time optimization**

In the beginning of pedestrian simulation frameworks, a common way to find a valid route to an exit for each of the simulated pedestrians consisted of abstracting a facility as a graph and using shortest path algorithms e.g. Dijkstra [1959]. It was assumed that people try to save energy and resources and thus use the path that is related to the minimum effort. The use of shortest paths implies the assumption that the pedestrians know the path to the nearest exit. However, in complex buildings, it can be difficult

to find at least any exit, particularly the one that is related to the shortest travel distance. Sometimes, global comprehensive knowledge about the facility's structure in combination with exact estimations of distances would be necessary to identify the shortest route. Though, many occupants in public buildings are very unlikely to possess this necessary knowledge degree. This applies especially for facilities with a lot of first time visitors. Sufficient and correct signage theoretically enables familiar as well as unfamiliar visitors to follow a short route to the outside. However, not all persons follow signage which i.a. has been shown by Galea et al. [2014].

Hence, the utilization of shortest path algorithms is based on assumptions that turned out to be wrong in many cases. Nevertheless, the application of shortest path algorithms is still a good choice for selected scenarios in which wayfinding and orientation is trivial or exits even can be seen from any point in the facility e.g. in stadiums or outdoor festival areas.

If a shortest path method is applied, situations can occur in which a large number of agents queue in front of an exit that is part of their shortest way. They queue at this door despite the existence of a further visible adjacent exit that is barely used. To avoid cases in which agents strictly stick to their original path and therefore accept long waiting times, travel time optimization algorithms e.g. Kretz [2009]; Guo and Huang [2011]; Kemloh Wagoum, Armel Ulrich [2013] have been introduced. These algorithms find paths that minimize the travel time and thus instruct the agents to use alternative ways to avoid jams. Still the majority of these optimizations imply the assumption that pedestrians possess comprehensive spatial knowledge and are able to evaluate path lengths accurately.

### **Route choice models which consider human wayfinding abilities**

**NOTE:** Major parts of this subsection (contentwise but partially also word-for-word) have already been published in Andresen et al. [2018].

In complex buildings the reliability of the above mentioned optimization methods is questionable. Therefore, further models have been introduced that consider human inabilities in terms of wayfinding. This comprises the consideration of wayfinding strategies of persons who are not entirely or even completely unfamiliar with the spatial structure of the building.

With the help of a queuing network Løvas [1998] investigated the impacts and consequences of discrete choices at the knots of the network depending on various types of behavioral pattern models. The behavioral patterns include a random choice, a path

following (frequently used path) and a directional choice behavior. The frequently used path model makes agents tend to travel on a determined path. By a prescribed probability the agents lose the path and proceed by using random choices. If the directional choice model is applied, agents prefer graph segments (edges) leading them to a specific direction.

Ehtamo et al. [2010] introduced game theoretic modeling which enabled unfamiliar agents in their software framework to observe and imitate route choices of other agents. Furthermore, agents' knowledge can be restricted arbitrarily so that they possibly only know about a fraction of exits.

Kneidl [2013] distinguishes between people that are familiar with a certain environment and those who are not or only to some extent. To model agents who have restricted information about their current environment, Kneidl [2013] introduces spatial inaccuracies concerning metrics and direction. Furthermore, human wayfinding is represented by various models including route choices that depend on the direction to the destination, on the preference of routes that avoid turns and on the movement of other people. Additionally, landmarks are introduced serving as subgoals or rather subdestinations [Kneidl, 2013].

Kielar et al. [2016] created a unified routing model by utilizing the models of Kneidl [2013]. By unifying the models that represent persons with profound knowledge and persons who are unfamiliar with the environment his new approach grants the possibility to simulate pedestrians with several different degrees of knowledge. In addition, the agents are using a mixture of appropriate tools and strategies to find their way.

To find an exit without any knowledge about the spatial structure, von Sivers et al. [2016] present modeling approaches for search strategies (random search and nearest room/door heuristic (NDM)). Using the random search algorithm agents randomly select the next possibility to proceed. Agents proceed to the nearest located (measured by euclidean distance) room or rather door if the NDM is utilized. In both cases the agents avoid crossings leading to rooms they already have visited.

Tan et al. [2015] created an approach which combines a personalized spatial cognitive road network with implementations of selected routing strategies, e.g. the use of the shortest path, the most familiar path or the least crowded path.

Furthermore, models can be found in the literature that consider the human incapacibilities to perceive signage, for example in dependency on the signs' properties, on the distances and the observation angles to signs or on lighting conditions [Filippidis, 2006; Xie et al., 2007; Kretz et al., 2011; Nassar, 2011].



In contrast to the scientific community that investigates pedestrian dynamics where human wayfinding approaches still are rare, computational models of wayfinding are widespread in the field of cognitive science, neuroscience, artificial intelligence, robotics, etc.. On the one hand, there are neural architectures explicitly modeling mechanisms in the brain which are involved in the wayfinding process, incl. learning, forming and retrieving spatial memories. Models by Burgess et al. [2000]; Madl et al. [2013] are belonging to this group.

On the other hand, there are symbolic models modeling wayfinding and navigation abilities in a more generalized way. They make use of rules and facts which are representative for neural procedures. Partly, the models, combined with sensory input functions, are implemented in robot systems enabling the robot to navigate autonomously. This includes the recognition of landmarks, destinations and starting positions, determination of the own location and decision making. Kuipers [1978]; Gopal et al. [1989]; Kuipers [2000]; Beeson et al. [2010] are to be mentioned among symbolic models. See Madl et al. [2015] for a comprehensive overview of symbolic models and neural architectures.

By this time, computational cognitive models are elaborated regarding a plurality of aspects and principles of human wayfinding. Many of them are, considered as a whole, not well suited for an implementation within a simulation framework for pedestrian dynamics. This is caused by the fact that a majority of those models are created to serve different purposes (research on architecture and mechanisms of the hippocampus, robot navigation with a particular relatedness to sensory input functions, etc.). Certainly, various basic ideas of the mentioned models can be adopted when creating a wayfinding model for pedestrian dynamics simulations.

### **Wayfinding studies**

Studies or rather experiments that investigate human wayfinding are vital to understand the underlying processes. In this context, it is i.a. of interest to figure out which wayfinding tools or strategies e.g. using spatial memories or following signage are used in a specific situation and how accurately human beings apply them. In the literature, many studies can be found that investigate learning, storing, retrieving, and implementing spatial memories, but also the perception of signage and the influence of environmental factors on the route choice decision. These studies were conducted by scientists of various fields such as psychology, neuroscience, cognitive science, geography, architecture, but also from safety and traffic scientists. Selected studies that are relevant for the present thesis are discussed in Chapter 2.

### 1.3 Thesis Motivation, Objective and Outline

Although various aspects, tools and strategies of wayfinding are already taken into account in the previously mentioned models there is still room for improvements. Software frameworks of the state-of-the-art consider selected or even only a single wayfinding aspect. However, studies showed that people solve wayfinding tasks with the help of multiple tools. Depending on the situation these tools are applied simultaneously or subsequently.

The goal of this thesis is to create a model framework that is able to predict evacuation processes or rather egress times more accurately than state-of-the-art software by considering human wayfinding aspects more thoroughly. For this purpose, this thesis introduces a software framework that considers multiple tools and their collaborations that are mainly involved to solve wayfinding tasks during evacuations. As the scope of this thesis is restricted, it will not provide explicit modeling approaches for all of these tools. Therefore, the author selected the tools and their according strategies that are applied in individual wayfinding tasks. In consequence, tools that use information from other persons are left out. This means, the agents of the proposed framework neither intentionally follow other pedestrians or imitate the others' route choices nor avoid other people or congestions.

Instead, explicit modeling approaches are presented that represent the structure and application of spatial memories, the perception and use of exit signage, and the utilization of wayfinding strategies based on environmental factors and generalized experiences. In addition to the individual models the framework incorporates rules that arrange their interferences. Furthermore, the framework is intended to be flexible and expandable so that still missing route choice models can be appended at any time.

The majority of the modeling approaches that are introduced in this thesis are event- and rule-based. That means, they consists of algorithms incl. instructions and if-branches that are executed in case of a specific event. Mainly, there are no mathematical equations or systems of equations that describe the models or their application. Instead, the steps within the algorithms are described and explained with the help of flow charts conceptually. The explicit implementation (source code) of the algorithms is not shown as it would go beyond the scope of this thesis. If the reader is interested in (specific parts of) the source code in order to reproduce (the results of) the framework or use it for own problems or purposes, he/she is referred to Andresen [2018].

Beside the modeling work that is shown in the next chapters, results of three wayfinding studies - a study conducted in an office building and two studies conducted in a subway station - are presented. They provide new insights in the selection and implementation of various wayfinding tools and strategies in office buildings and subway stations. Besides, with the help of these results the introduced modeling approaches are calibrated. It is shown that the calibrated models can reproduce the route choices of the studies' participants with a minor error. Particularly, it turns out that, in comparison to state-of-the-art route choice models such as shortest path models or random choice models, the framework is better suited to reproduce the route choice distribution that resulted from the study in the office building. The deviation between the observed route choice distribution and the distribution that is predicted by the framework is remarkably lower in comparison to the distributions from the other shown models.

Although the calibrated framework is capable of reproducing the resulting route choice distributions from the studies in good approximation, it is not able to predict a route choice of an individual in an arbitrary situation. The route choice of an individual may depend on a huge number of influencing factors. This thesis focus on selected factors that are considered to be mainly involved in a wayfinding process. If factors are contributing to the route choice that are not taken into account in this thesis, the framework will fail to predict the route choice correctly.

The models can only provide an educated guess of a route choice distribution of a group of pedestrians in which a majority relies on considered strategies and personal habits of individuals play a minor role. Even in the best case, this educated guess is only an approximation of a route choice distribution of a real system. Nevertheless, they extend state-of-the-art models by considering wayfinding abilities more thoroughly and contribute therefore to the improvement of pedestrian simulations.

The thesis is structured as follows: To understand the development of the models that are introduced in the following, it is necessary to describe the basics of human wayfinding first. Therefore, a detailed literature review about wayfinding and its aspects, tools and strategies is given in Chapter 2.

In Chapters 3, 4, 5, and 6 the mentioned software framework including its modeling approaches is described.

The subsequent two chapters (Chapters 7 and 8) provide insights in the results of three wayfinding studies and describe the models' calibrations that have been done with the help of these results.

In Chapter 9 the software framework is applied in the context of a simulation study of an evacuation scenario in a subway station. The study presents insights in the alteration of route choice distributions in dependency on the usage of specific wayfinding strategies. In this context, it is i.a. shown in how far the usage of signage affects route choices and therefore the overall evacuation process.

Finally, the software framework is assessed and its strengths, possibilities and limits are discussed in Chapter 10.

### 1.3. THESIS MOTIVATION, OBJECTIVE AND OUTLINE

---

# Chapter 2

## Human Navigation

NOTE: Major parts of this chapter (contentwise but partially also word-for-word) have already been published in Andresen et al. [2018].

### 2.1 Navigation - locomotion and wayfinding

Navigation tasks play a major role in the human life. People were and still are faced with them every day while traveling, merchandising, hunting and communicating. Nevertheless, the majority of underlying mental mechanisms involved in the navigation process are still not entirely known.

Navigational tasks require locomotive abilities on the one hand. These abilities enable people to move to visible destinations without colliding with walls, obstacles, other persons, etc. [Montello and Sas, 2006; Wiener et al., 2009]. Therefore, the immediate surrounding is observed by sensory-input systems [Montello and Sas, 2006]. The operational level of pedestrian dynamics modeling corresponds to the modeling of locomotion.

On the other hand, navigational tasks include wayfinding tasks. A wayfinding task comprises the localization of a specific non-visible destination and the planning of an appropriate route leading (possibly via subgoals) to the destination [Golledge, 1999; Montello and Sas, 2006; Wiener et al., 2009]. As a consequence wayfinding requires the localization of objects or places beyond the visible surrounding. Accordingly, the modeling of wayfinding processes corresponds to the tactical level of pedestrian dynamics modeling.

Downs and Stea [2005] describe wayfinding as a four step process. The first step comprises the determination of the own position, whereas the second step consists of the planning or choosing of a suitable route. If no route could be found, one has at least to choose a desired direction. Additionally, effective wayfinding requires the

ability to detect deviations from the desired route or the desired direction. Eventually, the final destination has to be recognized when it is reached [Downs and Stea, 2005].

Wayfinding requires the capability to perceive, memorize, retrieve, and assess spatial information in terms of mental representations of the environment. People’s abilities to solve wayfinding tasks successfully differ widely [Wolbers and Hegarty, 2010]. Particularly, individual differences emerge concerning their capability to encode and process spatial information [Wolbers and Hegarty, 2010]. Qualitative gender differences appear in the selection of spatial information and strategies aiding the wayfinding process [Lawton, 1996; Lawton et al., 1996; Wolbers and Hegarty, 2010].

## 2.2 The cognitive map

Lynch [1960] proposed that people built an abstracted mental image or representation of their large-scale<sup>1</sup> environment. Basically, this mental image describes what has been called cognitive map in the subsequent years by the majority of scientists from related fields. The representation consists of memorized objects and their spatial relationships to each other [Gärling et al., 1986; Golledge, 1999].

Primarily, Tolman [1948] introduced the term cognitive map in the 1930s. He conducted experiments with rats. Without being driven by stimuli the rats were able to retrieve the direction leading them to a destination they visited multiple times before. As a consequence, Tolman [1948] noticed that the rats hold the ability to memorize the position of specific places relative to others.

O’Keefe [1976] gave evidence about the fact that the rat’s hippocampal formation is mainly involved in the establishment of a reference map system (the cognitive map). The hippocampus stores and retrieves spatial memories by using place cells [O’Keefe, 1976]. Specific place cells are triggered when the rat reaches a specific point [O’Keefe, 1976]. It has been shown that further cells are collaborating with place cells in building the capability to store, retrieve, and use spatial memories. As related to these, head direction cells [Ranck, 1985], grid cells [Moser et al., 2008] and border cells [Solstad et al., 2008] are to be mentioned. A collaboration of similar cells serving orientation and wayfinding were discovered in the human and various other mammals’ brains [Ekstrom et al., 2003; Jacobs et al., 2010].

The cognitive map enables people to determine the relative location of a non-visible destination beyond their immediate surroundings by processing and evaluating

---

<sup>1</sup>The large- or medium-scale environment includes also parts of the surroundings which are not currently accessible by sensory-input.

the information in the map. In many cases cognitive maps of unfamiliar environments are slightly provided with information [Golledge, 1999]. Due to the frequently occurring gaps of information in spatial memories Tversky [1993] proposes to call the human mental representation cognitive collage instead of map. Even after multiple stays in an environment the related cognitive map may consist of incomplete, inaccurate information. The externalization of cognitive maps in the form of sketched drawings shows few similarities with the corresponding physical space [Golledge, 1999]. The sketched drawings suggest that the cognitive map is rather an inaccurate (abstract) representation [Carlson et al., 2010]. Especially errors concerning the exact metric distances between objects and angles between connections of objects, e.g. turn angles, occur [Golledge, 1999; Ellard, 2009]. However, the slight information can be sufficient to solve wayfinding tasks due to the fact that many tasks can be solved with the help of topological relations. A possible explanation for neglecting several detailed information or rather for only storing selected parts and topological information of the environment could be the efficiency and the minor requirements for memory that come along with this strategy [Ellard, 2009].

### 2.3 Landmarks and further items of the cognitive map

Landmarks are salient point or area objects in the environment and serve as the main components in the formation of the cognitive map [Golledge, 1999]. They are recognized and memorized because of their conspicuousness, uniqueness or rather disparity to other objects [Golledge, 1999]. Landmarks could be a place, a great tower, an old looking house, a statue or even a smaller object. A view of a set-up of multiple objects or a scene could also be considered as a landmark [Hund and Minarik, 2006; Hurlebaus et al., 2008]. Specific landmarks serve as anchor points or rather as the origin of the cognitive map's reference frame. Hence, people tend to determine other landmarks' and their own location relative to an anchoring landmark, for instance a high, globally visible tower [Golledge, 1999].

In many cases route segments start and end at landmarks<sup>2</sup>. The selection of proceeding paths or directions are often made at landmarks<sup>3</sup> [Golledge, 1999]. By tendency, landmarks are preferred to be internalized and remembered because of

---

<sup>2</sup>Landmark as origin or destination

<sup>3</sup>Landmark as an onroute choice point



### 2.3. LANDMARKS AND FURTHER ITEMS OF THE COGNITIVE MAP

---

their disparity concerning visible shape or structure [Arthur and Passini, 1992]. Nevertheless, as Lynch [1960] pointed out, people generally perceive and remember their environment differently. According to their purposes and interests people select, emphasize, and filter the objects they perceive from the environment [Lynch, 1960]. Consequently, objects without optical particularities are also remembered due to sociocultural or personal relevance [Appleyard, 1969]. A study by Golledge and Spector [1978] showed that 50 % of city objects were stated as remembered or rather familiar (landmarks) by almost all participants. The other remembered objects were related to personal interests.

The cognitive map is basically assumed to be the mental representation of landmarks and their spatial relations to each other. Information about the mentioned relations incorporates clues about direct or indirect connections (line or route segments) between landmarks [Golledge, 1999].

Fig. 2.1 shows a conceivable visualization of a fictional cognitive map and its items. The map does not incorporate any metric information. However, it provides topological information, particularly it shows which objects are directly connected to each other by a walkable path. Furthermore, the wayfinder is able to infer spatial relations qualitatively such as "starting from the T-junction the cafeteria lies beyond the entrance".

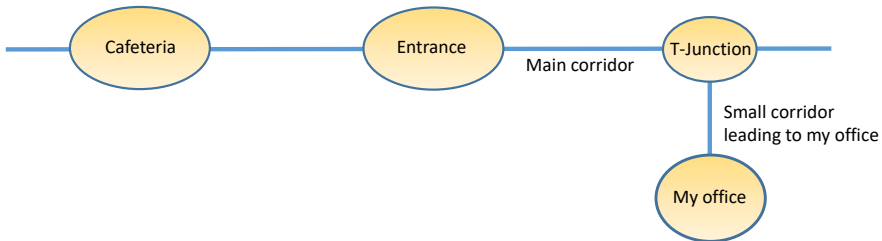

Figure 2.1: Possible mental representation of a person's workplace.

## 2.4 Wayfinding - Procedures and tools

In order to obtain a deeper insight in wayfinding mechanisms, individual procedures, components, aspects, and tools accompanied by the wayfinding process are discussed in the following subsections.

### 2.4.1 Spatial memories - Cognitive maps vs. action-based representations

In terms of human spatial memories a distinction is made between action-based representations (route knowledge) and the cognitive map or rather cognitive map representations (point and survey knowledge).

#### Route knowledge

Route knowledge (action-based knowledge) enables the wayfinder to follow a set of route segments. In general these route segments are connections between landmarks. Having reached a landmark at the end of a route segment, the wayfinder adapts his/her direction of travel heading towards the next landmark [Klippel et al., 2005; Hurlebaus et al., 2008] (for instance: at the Empire State Building, turn left and follow the avenue). Moving step by step from landmark to landmark the wayfinder finally arrives at the desired destination (path following) [Allen, 1999]. At every step the wayfinder only knows the position of the next subgoal and is not able to establish an overview of the relative positions of the landmarks. He/she neither can point directly to the desired destination from the starting point of the route nor give information about a position of a subgoal unless it is the adjacent one. Hence, the wayfinder is not able to plan paths or routes, for instance short cuts, departing from the original route [Allen, 1999; Wiener et al., 2009]. Path following is accompanied by less effort as the wayfinder's tasks are restricted to the recognition of landmarks and the implementation of the instruction associated with the landmark. In many cases people accomplish path following tasks without conscious reasoning, for instance when traveling on a very familiar route like the one from home to workplace [Thorndyke and Hayes-Roth, 1982; Allen, 1999; Wiener et al., 2009]. There is evidence that path following (responding to sensory-input and adapting the direction of motion) is achieved by using the caudate nucleus instead of parts in the hippocampus [Iaria et al., 2003; Bohbot et al., 2007].

**Point knowledge**

Point knowledge describes knowledge about the desired destination's location relative to the own position. There is no information about possible routes, route segments, subgoals or landmarks located between the current position and the destination. Thus, the wayfinder has to search for paths or routes taking him/her at least closer to the destination (path searching). Obviously, routes leading (approximately) to the desired direction are appropriate [Wiener et al., 2009].

**Survey knowledge**

Survey knowledge describes knowledge about multiple objects of the current environment, their relative positions to each other, and possible connections between them. Survey knowledge can be compared to a highly developed cognitive map. The wayfinder has the possibility to evaluate his/her mental map and to plan an appropriate path to the desired destination (path planning) [Wiener et al., 2009]. In many cases the choice of a route depends on shortest path or least effort calculations which could involve the planning of shortcuts.

Both point and survey knowledge requires the evaluation of cognitive map representations (objects' relations to the own location or other objects).

**2.4.2 External aid or information****Signs and maps**

To solve his/her wayfinding task, a wayfinder can look around for maps or signs possibly helping him/her. Given the case signs are available, the wayfinder can simply follow their instructions until he/she reaches a familiar place or the destination. Using and memorizing maps lead to the establishment of internal spatial information, particularly to cognitive map representations (see Sec. 2.4.1) [Wiener et al., 2009].

Signage is supposed to help evacuees (in particular unfamiliar ones) to find exits without detours. Though, fire incidents, drills, and studies, for example by Benthorn and Frantzich [1999]; Grosshandler et al. [2005]; Kobes et al. [2010]; Till and Babcock [2011]; Xie et al. [2012]; Galea et al. [2014]; Vilar et al. [2014], showed that people partially neglected or did not perceive signage. In fact, yet, there is little knowledge about the number of people who detect and follow signage in a specific situation.

Even though signs might be recognized in generic environments, it is not guaranteed that signage is perceived in real environments where positions of signs or their

size or salience are not optimal. Furthermore, in these situations, other objects provide visual stimuli and may distract the wayfinder. In fact, Xie et al. [2012] and Galea et al. [2014] conducted a study in an university building which showed that a conventional but clearly visible exit sign has been detected by only 39% of the unfamiliar participants. 33% of the familiar participants perceived the sign. 56.3% of participants of a study in a hotel by Kobes et al. [2010] stated to have seen and used signage in a scenario without the presence of smoke. 81.8% declared to have used signs in another scenario where harmless smoke was present at a specific location. In the scenario without smoke 25% chose a longer way although signage indicated a shorter one (versus 35% in the smoke scenario). Shiwakoti et al. [2016] gathered survey data about sign usage in underground stations. Therefore, people were asked to fill in questionnaires in trains or on concourse levels. 43.8% of the interviewed passengers stated to have seen exit signs. 41.3% of them considered signage to be useful. Tang et al. [2009] measured the average time needed for evacuation in a virtual office space. On average participants required 84.4s in the presence of new-version signs, 75.6s with old-version signs and 123.8s without signage. Although signage facilitated the evacuation, participants could not evacuate without making any mistakes at decision points or detours.

Especially if signage competes with attractions caused by environmental factors e.g. brightness or size of corridors, the relative number of people who rely on signs decreases [Vilar et al., 2014]. In the study by Vilar et al. [2014] up to 65% (depending on the situation) did not follow the signage but rather proceeded via an attractive corridor. Duarte et al. [2014] conducted a study in a small virtual maze. Also in this, participants partially ignored (conventional static) exit signage. On average the subjects followed signage only 4.6 times instead of 6 possible times.

Studies by Morley [1997]; Wong and Lo [2007]; Xie et al. [2007]; Occhialini et al. [2016] showed that human beings are able to recognize and interpret signage correctly even from large distance if the attention is already directed to the sign. Furthermore, almost all participants of the studies by Xie et al. [2012] and Galea et al. [2014] who declared to have seen signage interpreted it correctly and followed the instruction. These results suggest that the low rates of sign usage mentioned above are not caused by the inability to identify or to understand the sign. Instead, the results suggest that signage is often simply not perceived.

Galea et al. [2014]; Duarte et al. [2014]; Künzer et al. [2016] revealed that dynamic signage which is more salient can increase the detection rates and thus the use of signage remarkably. 77% of the unfamiliar participants in the study by Galea et al.

[2014] stated to have seen the dynamic signage (detection rate for static signage was only 39%). In the virtual maze of the VR-study by Duarte et al. [2014] the average correct choices at the six decision points increased from 4.6 to 5.23 when using dynamic signage. Furthermore, in a study in a virtual environment by Bode, Nikolai W.F. et al. [2014] signs had a strong influence on the participants route choice since the signage was very large and prominent.

## **Herding**

In certain situations some people follow others and adopt their route choices assuming that the others are more familiar with the environment. Particularly in evacuation situations this behavior might be prevalent as the wayfinders are aware of the fact that they, most likely, pursue the same aim or the same spatial destination (find an exit). This behavior is called herding [Helbing et al., 2002; Schadschneider et al., 2009; Kielar et al., 2016]. As the strategy to follow others can remarkably influence the evacuation progress, the author explicitly considers herding as a wayfinding strategy. Particularly, herding behaviour has been observed when people are facing higher stress degrees, for example when compromised by smoke [Helbing et al., 2000; Helbing and Johansson, 2010]. However, Moussaïd et al. [2016] found that the number of people in the surrounding who head for the same route has a higher impact on the herding behavior of a single person than his/her stress level.

### **2.4.3 Generalized knowledge**

Humans tend to classify new experiences (surroundings or situations) [Anderson, 2010; St. Pierre and Hofinger, 2014]. They compare a new surrounding or situation with similar familiar ones which already have been well analyzed. If one or multiple similar experiences could be recalled, the new one can be categorized together in the same class with comparable ones. Once classified the experience will be related to attributes, implications and expectations of the according class [Anderson, 2010; St. Pierre and Hofinger, 2014].

Clues about categories of experiences also influence the human ability and approach to solve wayfinding tasks [Murakoshi and Kawai, 2000; Kalff and Strube, 2009]. Although being faced with an environment never visited before, information about the respective class of the environment can be retrieved. This information does not incorporate the explicit spatial set-up of a building or environment. In contrast, it gives clues about properties shared with other surroundings of the same type or

category [Wiener et al., 2009; Kalff and Strube, 2009]. This type of information is called generalized knowledge.

Located in an arbitrary train station, for instance, people expect the possibility to enter trains via platforms. Leaving a subway train they expect the exit of the station somewhere upstairs. In offices and public buildings people know that they have to use circulation rooms to reach their destination successfully and efficiently.

A majority of search strategies implies the preference of specific doors, streets, route segments or simply specific directions based on generalized knowledge. The expedient strategy to prefer circulation rooms in office buildings, for example, is based on generalized knowledge about the structure of office buildings.

Even if the wayfinder has to select one of multiple proceeding ways that consist of the same room type, he/she possibly prefers one specific way. In certain situations people are attracted by specific attributes of a room or corridor. For example, it has been shown that people favor brighter and wider corridors which provide the greater field of view over other corridors [Peponis et al., 1990; Vilar et al., 2013, 2014].

## 2.5 New taxonomy of wayfinding tasks in evacuations

In order to summarize the previously described findings that are of particular interest to understand human wayfinding in evacuations, the author proposes a new wayfinding taxonomy. The taxonomy is an adapted and restructured version of a taxonomy introduced by Wiener et al. [2009] (see Fig. 2.2). The purpose of the new taxonomy is to show the tools and strategies that are particularly used in evacuation situations.

In principle, the taxonomy shows the above discussed separation of the individual wayfinding tools and their according strategies. In this context, a wayfinding strategy is the application of its according tool.

It has been distinguished between external clues recorded during the wayfinding process from sensory-input (see Sec. 2.4.2)<sup>4</sup>, internalized spatial memories from preceding visits including the subdivision into route, point, and survey knowledge (see Sec. 2.4.1) and generalized experiences (see Sec. 2.4.3). With the help of route, point, or survey knowledge the strategies path following, path searching or path planning can be applied (see Sec. 2.4.1). Dependent on the type of available external clues maps or signs can be used or other people can be followed (see Sec. 2.4.2). Based

---

<sup>4</sup>Not including the recognition of internalized objects (landmarks)

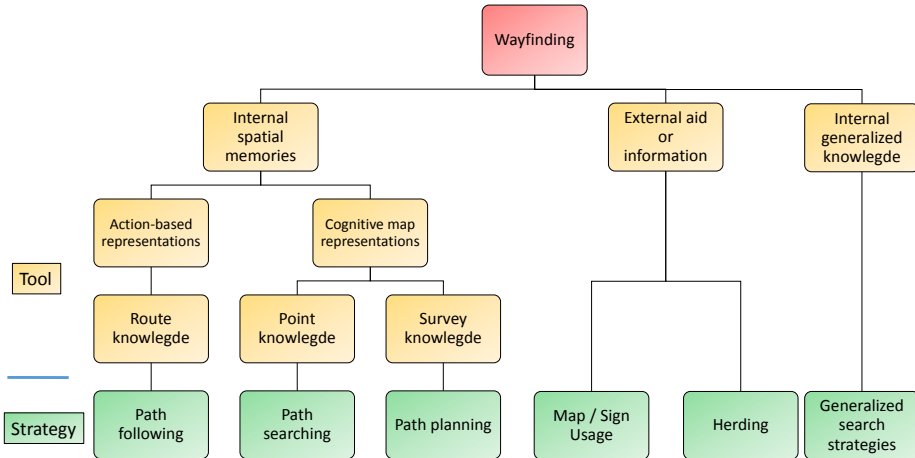

Figure 2.2: A wayfinding taxonomy showing tools and strategies which are used to solve wayfinding tasks in evacuation situations. The taxonomy is based on a taxonomy by Wiener et al. [2009].

on generalized experiences expedient search strategies e.g. use circulations (see Sec. 2.4.3) can be applied.

It is assumed that, in an evacuation situation, a person proceeds to or tries to find a specified destination, in most of the cases a specific exit or at least any exit. The destination could also be the position of a friend or a family member who has been separated from the wayfinder. However, undirected wayfinding behaviour, for example an purposeless pleasure walk, is very unlikely to be observed in an emergency. Thus, in contrast to the taxonomy by Wiener et al. [2009], undirected wayfinding is excluded.

## 2.6 Discussion

The findings of the above mentioned studies suggest that people’s choice of their wayfinding strategy is strongly dependent on the environmental features such as signs, other objects, other people, and personal attributes such as stress level, spatial knowledge degree, and personal habits. However, although single wayfinding strategies such as following signage, the use spatial memories or the application of search strategies based on generalized knowledge have been observed empirically, it is not

entirely known in which situations specific wayfinding strategies are mainly applied. Still there is more research needed in order to be able to understand the human wayfinding process entirely.





## Part II

# Modeling Cognitive and Perceptual Abilities for Wayfinding

---

# Chapter 3

## General properties of the software framework

### 3.1 Miscellaneous

As mentioned before, the here presented modeling approaches are developed to represent human cognitive and perceptual abilities in the context of wayfinding. That means, the models enable agents to plan, choose or find routes that lead them to a specific destination (wayfinding capabilities - tactical level). The operational level of pedestrian dynamics modeling is not part of this thesis.

However, the cognitive approaches are connected to the software framework Jülich Pedestrian Simulator (JuPedSim). JuPedSim is an open-source software package to simulate pedestrian movements. Multiple operational models are implemented within the package which take care of the agents' abilities to move to a visible target, steer around obstacles or interact with other pedestrians (locomotive capabilities - operational level). These include i.a. the generalized centrifugal force model Chraibi et al. [2010] and the collision-free speed model Tordeux et al. [2016]. All applications of the here presented wayfinding models are accomplished in combination with JuPedSim. Please refer to Kemloh et al. [2016] for more information about JuPedSim.

A spatial structure that is modeled within JuPedSim consists of walls, walkable areas on a floor e.g. common or circulation rooms, stairs and at least one exit. All calculations are done in 2 dimensional space.

In the following, it is explained how agents perceive the environment of JuPedSim and identify possibilities to proceed their way.

## 3.2 Perceptual abilities

For perceiving the environment of JuPedSim and objects within, the model framework considers an individual isovist for every agent. An isovist or visibility polygon describes the area in an environment which is visible from a certain position (see Figs. 3.1(a)/3.1(b)). The heading direction of the observer is not taken into account in this regard. Consequently, an isovist describes the area that can be seen if an agent had a view of  $360^\circ$ .

The isovist of an agent is updated (recalculated) after every time interval  $\Delta t$  (suggestion  $\Delta t = 0.2\text{s}$ ) as it changes during the movement of the agent<sup>1</sup>.

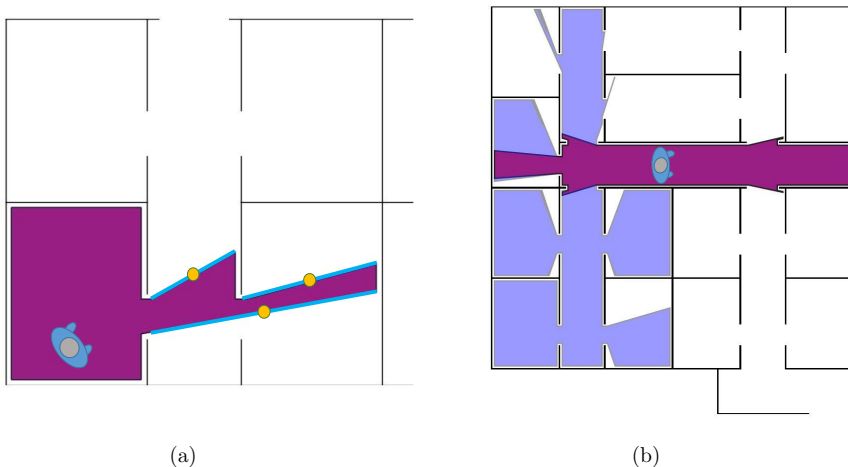

Figure 3.1: a) The filled violet polygon describes the visible area (isovist) from the agent's current position. Blue lines depict possible crossings to proceed. Possible crossings are represented by their centers (orange) to facilitate calculations. b) The filled violet polygon describes the visible area (isovist) of the agent. The union of the blue and violet polygon describes the area which the agent has already seen during its travel.

Agents are able to differ between segments of the visibility polygon that overlap with walls and those that do not. The agents consider segments which do not overlap with walls (marked blue in Fig. 3.1(a)) as possibilities to continue their way to their destination. These segments are represented by their centers in order to facilitate subsequent calculations.

<sup>1</sup>The computation of isovists are done by the C++ libraries CGAL [The CGAL Project, 2017] and BOOST [Schäling, 2011]

Furthermore, JuPedSim's environment provides at least one exit and transitions to stairs (if present in the regarded scenario). These objects are related to points with fixed locations in the environment. Exits or transitions to stairs are included into the possibilities to proceed if they are located within the isovist.

### 3.3 Short term memories

It is assumed that people are able to remember their recent steps or rather the area they recently have visited. Thus, agents are provided with a second polygon that represents their short term memory about the rooms or areas they already have seen. This polygon consists of the union of all so far calculated isovists (see Fig. 3.1(b)). Consequently, in total, each agent possesses two different polygons. On the one hand, there is the polygon (violet in Fig. 3.1(a)) that represents the currently visible area. On the other hand, there is the polygon which describes the already explored area<sup>2</sup> (blue in Fig. 3.1(a)).

This concept considers only spatial memories gathered after the start of the simulation. These memories are called short term memories to distinguish them from the spatial knowledge in the cognitive map and generalized knowledge. Cognitive map knowledge and generalized experiences represent long term memories that, in principle, need more than one visit to be able to be built up.

Analogous to the polygon indicating the current visible area agents are capable of identifying segments of the short term memory polygon that do not overlap with walls.

After a certain duration people might forget where they have been and are not able to re-recognize already visited areas. Thus, in certain situation it is reasonable to cut out specific parts of the polygon that represents the seen environment. For this purpose, a possible approach would be to cut out the parts that are far away from the agent's current position (suggestion 40-50 m).

### 3.4 Selecting an appropriate visible target

In specific situations, particularly when an agent approaches a dead end (see Fig. 3.2), it happens that crossings to unexplored terrain are not a segment of the current visible area (see Fig. 3.2). In these cases agents are faced with two decisions. They first have

---

<sup>2</sup>In this context, the area is meant that has been explored during the actual movement of the agent after the start of the simulation

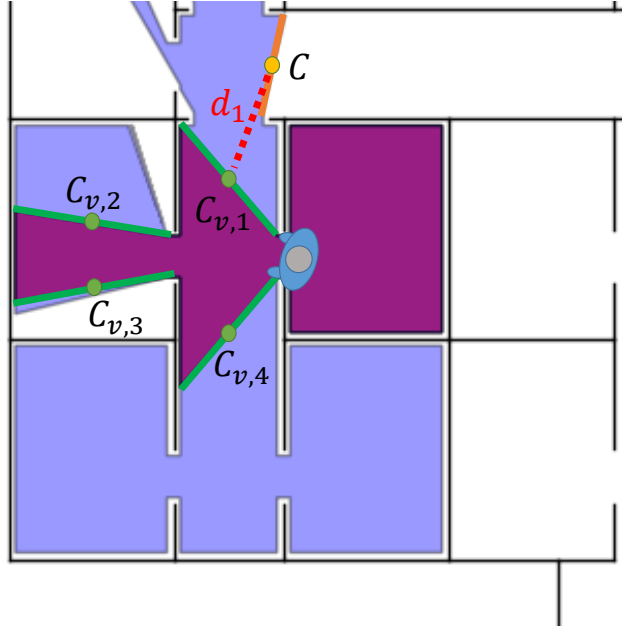

Figure 3.2: a) The environment that the agent has already explored is marked blue, the area that is currently visible is marked violet. The agent can choose between four visible crossings ( $C_{v,1}$ - $C_{v,4}$ ) (green) to proceed to the previously selected crossing to unexplored area  $C$  (orange). The euclidean distance  $d_1$  between the visible crossing  $C_{v,1}$  and the crossing to unexplored terrain  $C$  is marked red.

to select the best crossing (marked orange in Fig. 3.2) to proceed to non-visited area. Secondly, they need to find an appropriate visible crossing (marked green in Fig. 3.2) to reach the segment of explored area selected in the first step.

The selection of the best choice to proceed to unexplored terrain is based on various wayfinding tools. Thus, it needs multiple detailed considerations that are provided in the subsequent chapters.

In contrast, the best visible crossing is always determined in the following manner. The euclidean distance  $d_i$  (see Fig. 3.2) between every visible crossing  $C_{v,i}$  and the previously selected crossing to unexplored terrain  $C$  is calculated. For the calculation of the distances the representing center points are used. Based on the assumption that especially in evacuation situations people prefer to reach their destinations directly and efficiently, the closest visible crossing is considered to be the best choice. The closest crossing is the crossing that is related to the smallest distance  $d_i$ . This applies also if both the visible crossing and the crossing to unexplored area are identical.

### 3.5 Restrictions to the selection of crossings - benefit rule

As mentioned before, the isovist of an agent obviously changes during its movement. Thus, visible crossings appear, disappear or their size or position changes. Due to the change of the isovist, the distances  $d_i$  between visible crossings  $C_{v,i}$  and the selected crossing to unexplored area  $C$  are likely to vary considerably. Hence, in such situations, agents quickly update their decisions. In some cases agents therefore oscillate at points as their decisions switch back and forth between two or multiple possibilities. Similar oscillations can occur within the selection of crossings to unexplored area if multiple crossings serve almost equally well to get closer to the destination.

In order to avoid this behavior, a benefit rule is introduced. This rule instructs agents to maintain their decision principally or to stay with the previously selected crossing. Only if the previously selected possibility has disappeared (a dead end, for example) or another crossing provides a remarkable higher benefit, the agent is supposed to change its mind.

In the context of the selection of a visible crossing it is suggested to change decisions only if the distance  $d_i$  related to another crossing is lower than 75% of the distance associated with the best choice in the last calculation step (if existent).

The flow chart in Fig. 3.3 summarizes the steps that are part of the benefit rule.

### 3.6 Exploration and search strategies

The agents already possess enough capabilities to explore a facility looking for an exit by themselves. However, for now, the agents are not provided with any information or hints about the location of exits. They have to apply a search strategy that determines how they select a crossing to unexplored area to proceed their search for the outside.

In this work, the nearest door heuristic (NDH) and a search by random choices are introduced [von Sivers et al., 2016; Andresen, 2016].

Using the random search agents select a crossing to unexplored area randomly. In the context of the random search, no crossing provides more or less benefit compared to others. Thus, the benefit rule causes agents to use a selected crossing as long as it exists. With the help of these rules, agents are capable of exploring a facility until they find an exit by coincidence or have explored every single part.



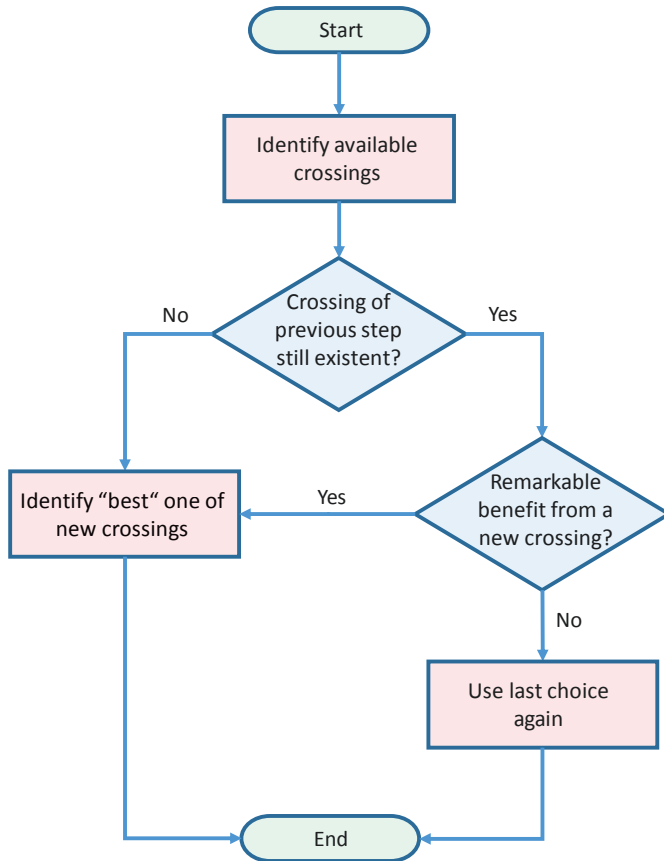

Figure 3.3: Procedure 1: Restrictions to the selection of crossings - The benefit rule. A new crossing is only selected if it provides a remarkable benefit in comparison to the crossing which has been chosen in the previous step. The procedure applies for both visible crossings and crossings to unexplored area. In terms of the selection of a visible crossing a candidate provides a remarkable benefit if the respective distance  $d_i$  to the previously selected crossing to unexplored area is remarkably lower (suggestion: 25 %). For more information about the benefit rule in the context of the selection of a crossing to unexplored area see Sec. 4.1.2.

The nearest door or nearest room heuristic causes agents to head to the closest room that can be seen from their position (see Fig. 3.4). In the here presented framework, this heuristic is applied by instructing agents to select the nearest crossing



ities to proceed to unexplored area (crossings) in a building can be identified from the isovists. Among these possibilities expedient crossings are selected to move to the exit. The decision can be affected by models of wayfinding tools and strategies that are discussed in the following chapters. If the selection is not influenced by wayfinding tools at all, search strategies e.g. random choice or the nearest door heuristic are applied. Furthermore, a visible crossing is chosen that serves well to reach the previously selected crossing to unexplored area.

Fig. 3.5 summarizes this chapter by showing the steps that are processed within the framework starting from the identification of crossings from the environment through the selection of a visible subdestination.

The above presented methods represent human perceptual, (short term) memorization and decision making abilities in a simplified and generalized way. Nevertheless, the approaches come along with advantages over state-over-the-art approaches in terms of creating more realistic agent behavior.

For example, due to the introduction of isovists, agents only recognize and consider objects that are in their field of sight. Furthermore, isovists open possibilities to model search strategies based on current visual information.

In addition, the approaches improve the usability of the software framework in comparison to frameworks that abstract spatial structures as graphs. In these frameworks, mutually visible waypoints have to be set that serve as intermediate subdestinations e.g. doorways for the simulated pedestrian. These waypoints are necessary to ensure that a valid path to the outside can be found for each of the agents. For the application of the here presented approaches no waypoints are necessary and it is not needed to abstract or subdivide a structure at all.

The question remains what happens if a visible target has been determined. How does an agent get to the target and how does it steer around obstacles or interact with other agents to reach the target? These questions deal with locomotive capabilities and are therefore not part of this thesis. Instead, the questions are left to the operational models of JuPedSim. The tasks of the presented model framework are considered as accomplished if a visible destination has been determined and can be given to JuPedSim.

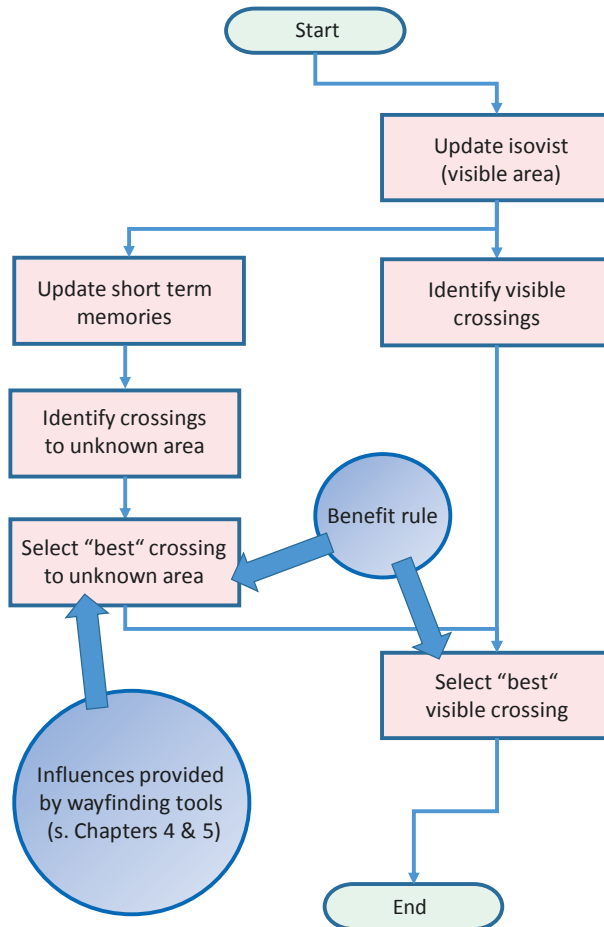

Figure 3.5: Procedure 2: Procedure to identify crossings in the visible area that are possibilities to proceed to an exit and to select one of them that serves best to reach the outside efficiently.



# Chapter 4

## Spatial knowledge - A cognitive map approach

NOTE: Major parts of this chapter (contentwise but partially also word-for-word) have already been published in Andresen et al. [2018].

In this chapter modeling approaches are introduced that represent the configuration and application of human spatial knowledge, the cognitive map. In this context, it is explained in detail how the modeled cognitive map contribute to an agent's route choice or rather influence the decision which crossing to unexplored area (see Sec. 3.2) should be taken.

The main contribution of the model is the ability to describe partial and/or inaccurate spatial knowledge. The approaches that are presented in the following consider all kinds of cognitive map representations (point and survey knowledge) (see Sec. 4.1) and an approach to model route knowledge (see Sec. 4.1.3). Furthermore, approaches to model generalized knowledge (see Sec. 4.2) are comprised.

### 4.1 Modeling cognitive map representations

As mentioned in Sec. 2.2, the human cognitive map often do not contain comprehensive and accurate information. The approach described in the following models incomplete, inaccurate or even wrong knowledge. It considers spatial representations (cognitive maps) that contain landmarks and their spatial relations to each other and to the wayfinder's location. To introduce spatial (especially metric) inaccuracies, the model does not contain the exact (zero-dimensional) positions of its landmarks. In contrast, these positions are described by ellipses (see Fig. 4.1).

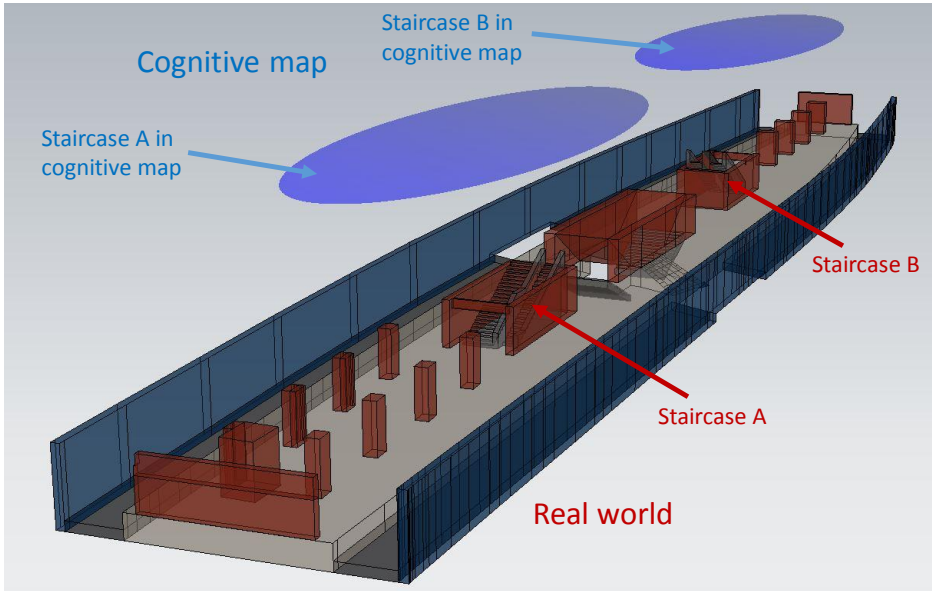

Figure 4.1: Representation of landmarks (here stairs) in a modeled cognitive map. The ellipses depicts the inaccuracy of the knowledge about the positions of landmarks.

The ellipses represent the inaccuracy of a wayfinder's knowledge concerning both the angle and the distance to a landmark. The spatial knowledge degree can be manipulated by including or omitting landmarks or by changing size, shape or position of the ellipses. The exact position of a landmark does not necessarily have to be located within the according ellipse. Hence, the modeled cognitive map might provide very inaccurate or even wrong clues about the relative positions of the agent's location and landmarks. In addition, the cognitive map holds information about known connections between landmarks (see Fig. 4.2).

Before the start of a simulation all agents are provided with an individual list of specific landmarks (incl. the properties of their elliptical representation). An additional individual list provides an agent with information about connections between landmarks.

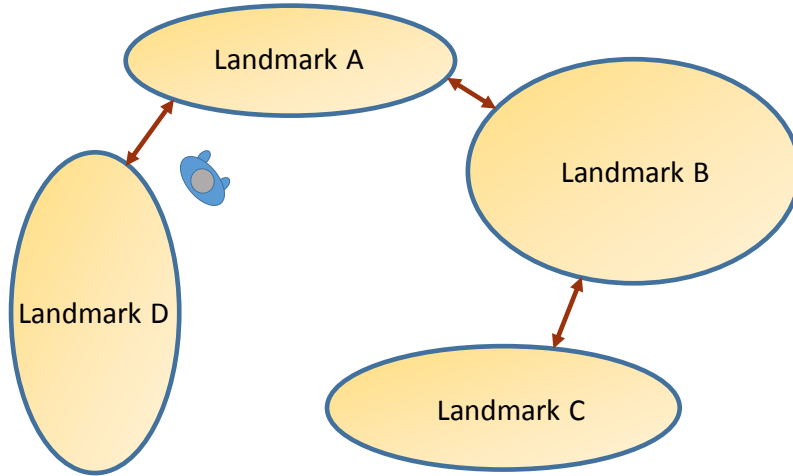

Figure 4.2: Representation of landmarks in a cognitive map. The ellipses depict the inaccuracy of the knowledge about the landmarks' positions. Thin arrows mark connections between landmarks.

#### 4.1.1 Evaluation of the cognitive map

Fig. 4.3 shows an agent's possible cognitive map of a fictional office building. The cognitive map can be regarded as a mental representation of someone's survey knowledge as it is filled with a relatively high number of landmarks and connections. The spatial structure in the background is not part of the map. It is only shown for demonstration and explanation purposes. In the context of its route choice decision the agent is using this set-up of landmarks and connections.

Fig. 4.4 describes how the cognitive map is evaluated or rather how the next step or next subdestination (in form of a landmark) is determined within the wayfinding process. The actual example case is regarded. Following the procedure shown in Fig. 4.4 the agent looks for the location of a main destination in the cognitive map. A main destination is a special landmark that represents a final destination, for example a known exit.

If at least one main destination could be found, the agent looks for the closest landmark in its surrounding which is connected (possibly via other landmarks) to the destination(s). In the example case, the closest one (considering the euclidean distance between the center of the landmark and the position of the agent) of all landmarks that are connected to the main destination is Landmark A (marked green).



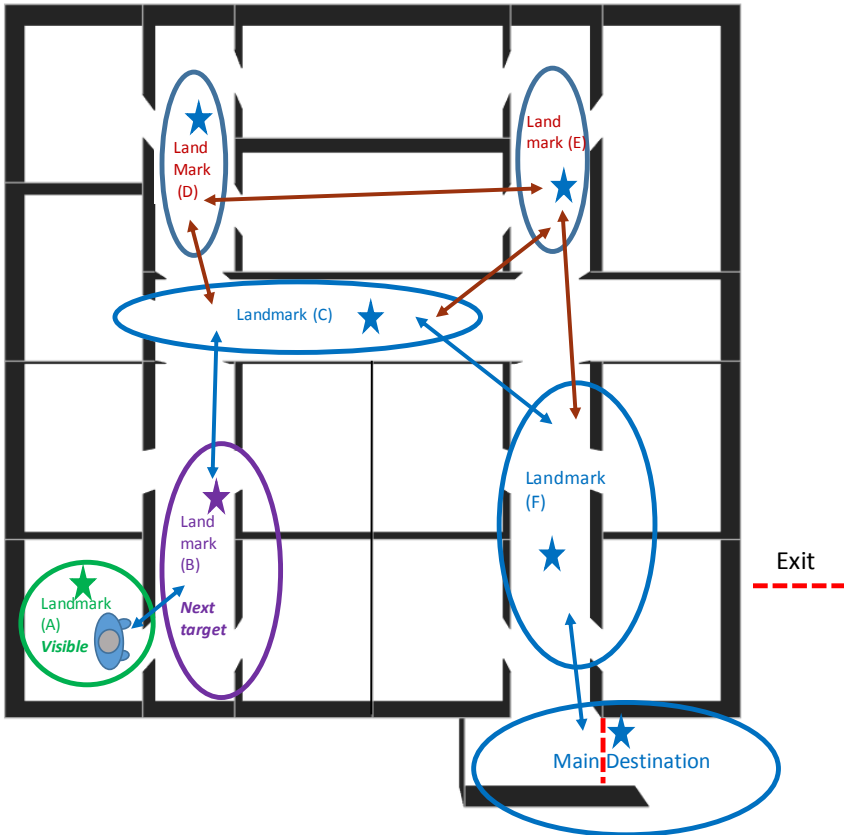

Figure 4.3: In the background: Spatial structure of a fictional office layout. In the foreground: A conceivable cognitive map of the structure in the background. The ellipses represent the inaccurate idea about the landmarks' positions within the map. The arrows depict connections between the landmarks. The stars mark the real landmarks' positions.

There are several chains connecting Landmark A and the final destination. The shortest one is the chain A-B-C-F-Destination. Blue arrows are used to mark the chain in the figure. The lengths of the connection chains are calculated by accumulating the distances between two randomly determined points within two adjacent landmarks.

If Landmark A is already in the agent's sight (landmark is located within the agent's isovist), the next one in the connection chain to the destination, namely the landmark Landmark B (marked violet), will be treated as the next subdestination.

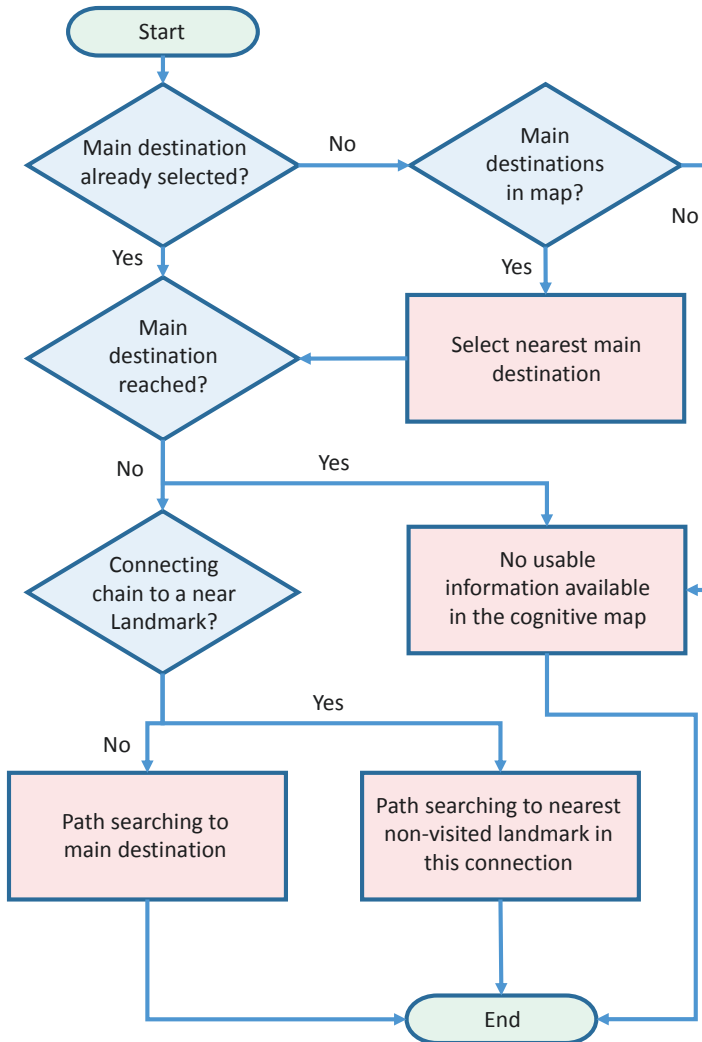

Figure 4.4: Procedure 3: The figure shows the algorithm which is used to evaluate the items in the cognitive map and to determine a suitable subdestination (landmark). The algorithm is executed every time an agent's isovist has been updated.

As described in Sec. 2.2, the term landmark can refer to single objects e.g. salient statues, furniture, paintings but also to scenes such as a view on a whole corridor. Nevertheless, for reasons of simplicity, the real position of a landmark is defined by a single point (see stars in Fig. 4.3) instead of an area. If the real position is located

within the current isovist of an agent, the landmark is considered as seen or visited.

Subsequently, the path searching algorithm which is explained in the following subsection is initiated considering the landmark Landmark B as the next subdestination.

Every time the agent's isovists changes, the above mentioned procedure is initiated. After the agent has left the first room in the example, it reaches the Landmark B. Consequently, following the procedure again, Landmark C is identified as the next subdestination. With the update of the isovists the procedure is repeated until the agent arrives at the main destination eventually. Given the case the agent has reached the ellipse of a landmark or main destination but the actual landmark is still not in sight, information from the cognitive map is not used. The agent has to rely on other information or rather search strategies to make its next route choice decision. The same applies for cognitive maps without any main destination.

### 4.1.2 Path searching to landmark

The path searching algorithm has been developed in order to determine the crossing to unexplored area that serves as the best choice to reach the landmark which has previously been set to be the next subdestination on the way to the main destination. In this procedure, it is of no matter if the landmark is very far away from the agent or in one of the adjacent rooms. The algorithm even allows path searching to the main destination itself which might be necessary if no landmarks except for the main destination are known (point knowledge).

In principle, the path searching algorithm is based on the assumption that it is reasonable to choose a proceeding way which is located in the same direction as the (sub-)destination. To find out which way is the best choice in this regard, the angle  $\alpha_i$  is determined for every available crossing to unexplored area.  $\alpha_i$  describes the angle between the line segment  $\vec{PL}$  from the agent's position to the nearest point on the ellipse that represents the landmark's location and the line segment  $\vec{PC}_i$  from the agent's position to the center point representing crossing to unexplored area  $C_i$  (see Fig. 4.5). All available crossings are ranked depending on their related angle  $\alpha_i$ . The best crossing among all available ones is considered to be the one that is related to the smallest angle

$$\alpha_{min} = \min_i \alpha_i. \quad (4.1)$$

The crossing which is on top of the ordered list is used by the agent if no other factors influence its decision.

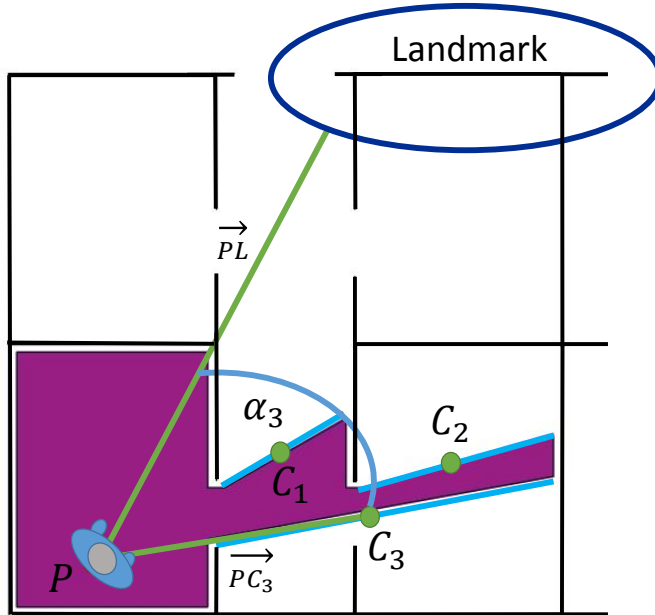

Figure 4.5: Angle  $\alpha_i$  between the line segment  $\vec{PL}$  from the agent's position to the nearest point on the ellipse and the line segment  $\vec{PC}_i$  from the agent's position and the center point representing the crossing to unexplored area  $C_i$ . The angle  $\alpha_3$  is exemplary depicted.

In specific situations, isovists change quickly remarkably so that different crossings are frequently considered to be the best choice. However, it is assumed that pedestrians stick to a certain decision unless another possibility provides a noticeable benefit in comparison to the current selection (previously mentioned in Sec. 3.5). Even less, they toggle between possibilities. Thus, a further rule is introduced which assesses the benefit of new crossings over the currently selected one. In the context of the evaluation of the cognitive map, an agent is instructed to change its route choice only if a crossing exists that is related to an angle  $\alpha_i$  which is about  $45^\circ$  smaller than the angle related to the previous choice.

### 4.1.3 Modeling action-based representations (route knowledge)

As described in Sec. 2.4.1, route knowledge relies on action-based representations. That means, following a route or rather using route knowledge does not require cognitive reasoning such as evaluating relations of multiple spatial objects. In case of recognizing a landmark a wayfinder who relies on route knowledge is provided with a memory indicating the next route segment leading to the next landmark. Although route knowledge is not belonging to the group of cognitive map representations, a model of route knowledge is proposed that is based on the cognitive map approach described above.

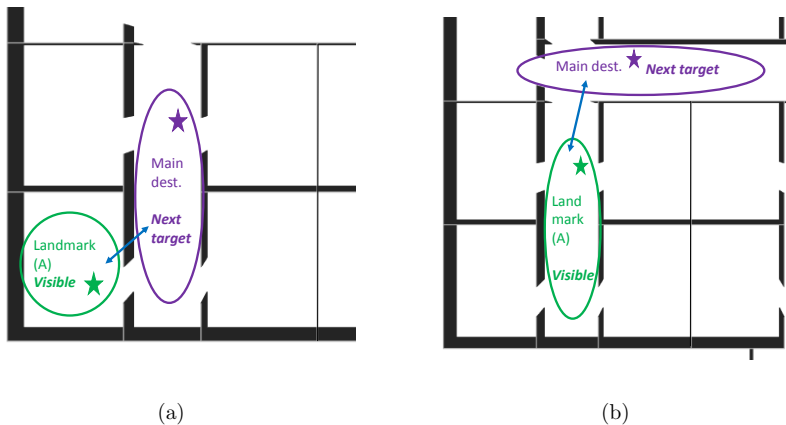

Figure 4.6: a)/ b) Possible current states of route knowledge always incorporating two connected landmarks.

Fig. 4.6 depicts the mental representation of an agent's route knowledge. The representations always include two landmarks and the clue that a connection between them exists. The first landmark is in the visibility range of the agent. The second landmark which serves as the next subdestination is not visible at first. When the second landmark becomes visible during the agent's movement, new memory is recalled. That means, the first landmark erases from the current memory, the second landmark becomes the first and a new (second) landmark is retrieved (see Fig. 4.7).

When the agent's isovist changes, the path searching procedure that has been described in Sec. 4.5 is initiated considering the second landmark as the new (intermediate) main destination.

Fig. 4.7 summarizes the steps that are processed to solve a route following task. The procedure shown in the figure is executed every time the agent's isovist changes and is repeated until the agent has evacuated or no further landmarks are available in the memory.

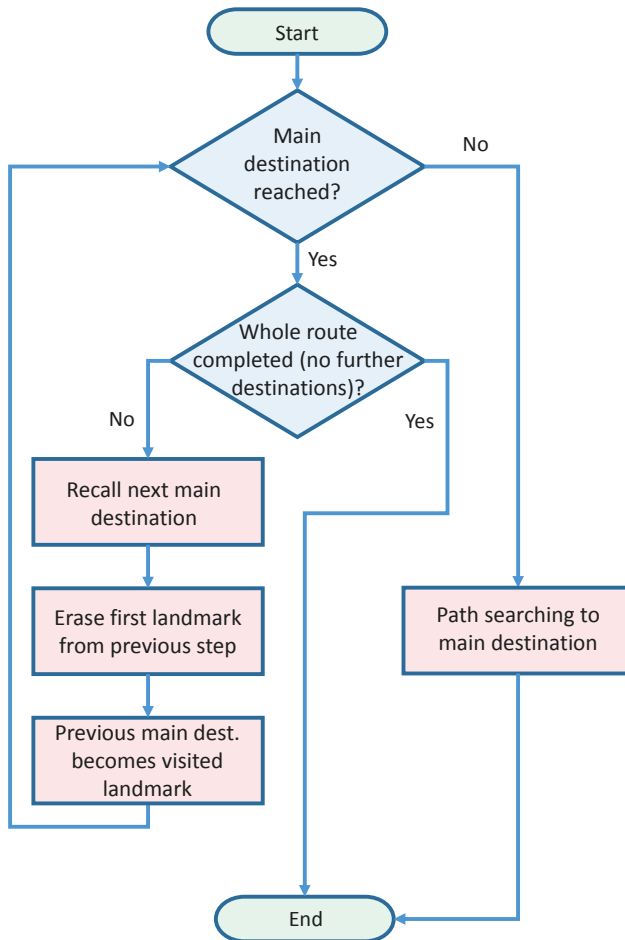

Figure 4.7: Procedure 4: Modeling route knowledge: This algorithm ensures that agents are provided with a new memory indicating the next step on their route if they have reached an intermediate destination. If there are no further destinations in the destination, the agent has completed its route.

## 4.2 Implementation of generalized knowledge

To cover the findings mentioned in Sec. 2.4.3, agents are enabled to recall generalized knowledge about their surroundings. In this context, agents are capable of identifying room types. Particularly, they are able to differentiate between entrances or lobbies, stairs, corridors, and common rooms. The agents prefer to use specific rooms as they know that these rooms are the better choice to reach their destination efficiently.

It is assumed that all persons that evacuate alone (adults) are capable of identifying a room type correctly in the majority of common buildings e.g. offices, schools, hospitals, universities, stations. Hence, agents can identify room types without any uncertainty.

Additionally, agents generally favor exits over any other crossing. They immediately head to an exit if the exit is located within the agent's visible range (isovist).

Consequently, crossings to unexplored area which are located in rooms of a specific type and particularly exits are given a special treatment so that they are preferred by agents. The hierarchy which shows the preference of selected room types in comparison to others is as follows:

1. Exits
2. Lobbies, entrances, foyers, atriums
3. Stairs (upstairs or downstairs depending on the case)
4. Circulation rooms e.g. corridors
5. Offices, common rooms, store rooms

The preferential treatment of exits and certain crossings is accomplished by sorting the list of crossings to unknown area based on the hierarchy shown above. Therefore, crossings that are located in rooms whose type is on top of the hierarchy are placed at the top of the list (see Fig. 4.8). This sort is done after the list of crossings already has been sorted considering information from the cognitive map (see Sec. 4.1.2). The order of the sorts comes along with the following consequences. Agents consider both generalized knowledge and their cognitive map. However, generalized knowledge overrules the route choice decision based on the cognitive map. That means, an agent rather stays on a circulation room than keeping the exact direction to a landmark by proceeding via common rooms. Nevertheless, the circulation room that complies best with the cognitive map is taken. Just in case there are only proceeding corridors that lead in the opposite direction, agents would walk away from a landmark.

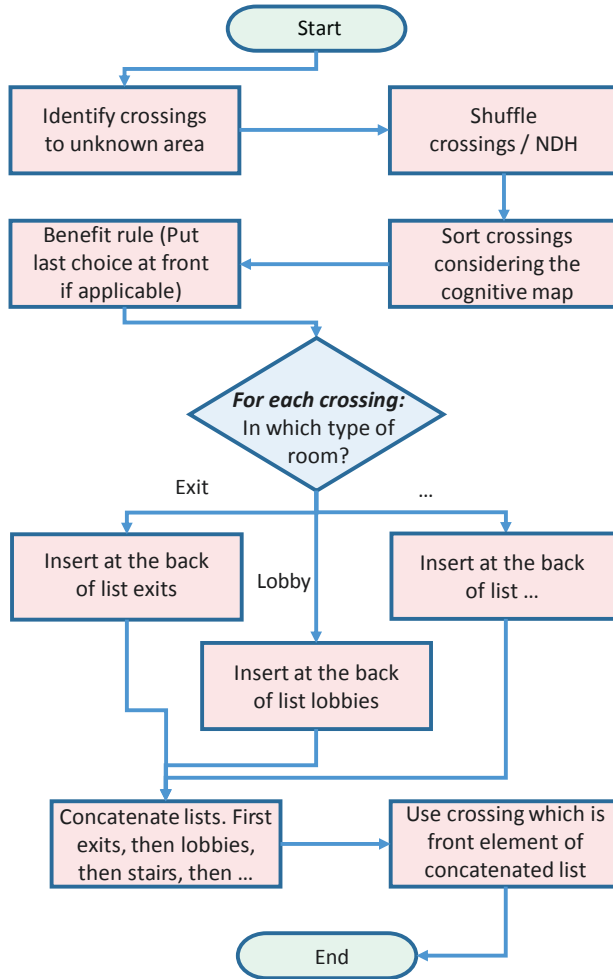

Figure 4.8: Procedure 5: Beforehand, the list of identified crossings to unexplored area is shuffled if agents are supposed to apply random choices as their search strategy. Alternatively, the nearest door heuristic (NDH) can be used as the search strategy. Subsequently, the list of crossings to unknown area is sorted under consideration of information from the cognitive map (see Sec. 4.1.2). Then, it is sorted again considering generalized knowledge. For this purpose, each of the crossings is inserted in the list that corresponds to the room type in which the crossing is located. Subsequently, the individual lists are put together. The above shown hierarchy of room types is taken into account. Consequently, exits (if present) are the first elements in the concatenated list, then lobbies (if present), than stairs (if present), etc..



### 4.2.1 Examples

In this subsection, an agent’s movement pattern under consideration of the previously introduced wayfinding models is discussed. For this purpose, the fictional building’s floor that already has been introduced in the above sections is used again.

The floor is depicted in Figs. 4.3, 4.6, and 4.9. The following example scenario comprises a single agent which is located in the left lower corner of the floor. It tries to reach the exit which is located underneath the corridor in the right lower corner.

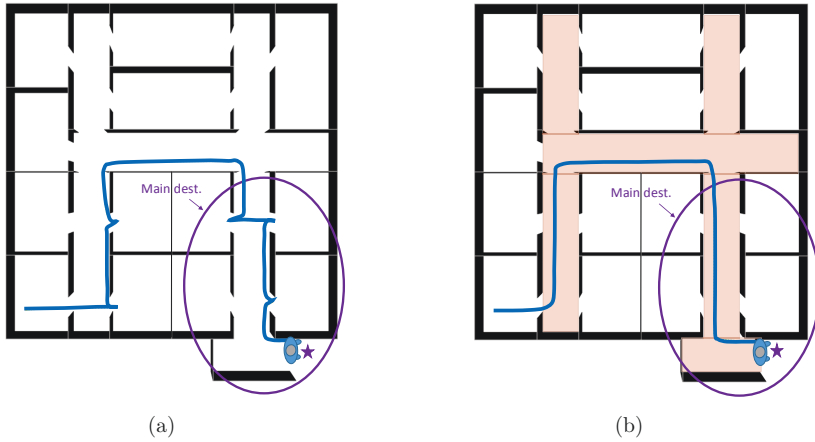

Figure 4.9: Trajectories of an agent starting in the left lower corner and trying to find the exit. a) The agent possesses a single clue in its cognitive map. b) The agent possesses a single clue in its cognitive map and knows about the function of circulation rooms.

Both example scenarios comprise the simulation of an agent provided with an inaccurate idea about the exit’s location (point knowledge). Its cognitive map is filled with one single item. In each of Figs. 4.9(a) and 4.9(b), the idea about the landmark’s location is depicted by the ellipse. In both examples, the nearest door heuristic is applied by the agents if neither its cognitive map nor generalized knowledge provides a decision.

In example a) the agent relies on its point knowledge without exception. The agent uses doors taking him purposefully (see Sec. 4.5) closer to the destination (see Fig. 4.9(a)).

Having started its journey, the agent crosses the first corridor (lower left corner) heading to the opposite doorway as this crossing is obviously the best choice to keep

the direction to the exit area. However, as the agent recognizes that it is located in a dead end, it turns around trying to reach the exit area by moving to the adjacent room. Here, it faces another dead end. Eventually, it arrives at the corridor located in the middle of the building which enables it to travel to the right lower region of the building.

In the following corridor on the right lower side, the agent's position is inside the ellipse which represents the landmark. Its cognitive map tells it, that it should be already in the nearer area of the landmark. However, it still has no visual contact to it. Inside the ellipse, the path searching procedure is not initiated anymore and the agent proceeds by exploring the environment starting with the nearest doorway (NDH).

Example b) comprises the combination of generalized and cognitive map knowledge. To highlight the effects of this combination, the agent is simultaneously provided with the ability to identify the rooms' types and with a directional sense of the exit's location. For this purpose, the color coded rooms in Fig. 4.9(b) are indicated as circulation rooms. The agent assumes the strategy to move to or to stay on a circulation room to be more expedient as to keep the direction to the destination (see Sec. 4.2). In consequence, having left the starting room, the agent proceeds to the corridor in the middle of the building as it is the only adjacent corridor. In the middle corridor the agent has to choose between multiple corridors. Obviously, the corridor in the right lower corner is the best possibility to come closer to the exit area. Following this corridor, the agent finds the exit eventually.

In this example scenario, the agent is moving to the destination without making any detours. Hence, in this example case, the strategy (go to and stay on circulation rooms) and a vague idea about the location of the destination are sufficient to find a short (in this case the shortest) route to the outside.

### 4.3 Summation and discussion

With the help of the modeling approaches examined in the previous sections, it is possible to provide simulated agents with incomplete, inaccurate, and distorted information about their medium- and large-scale environment.

For every agent, a cognitive map depicting its knowledge status can be created. The creation of various cognitive maps is possible by adding or omitting landmarks and/or connections between them. Furthermore, the information's accuracy about

the items in the map can be varied by changing size, shape and position of the ellipses which represent the landmarks or rather their positions. Various compositions of landmarks and possible connections between them are conceivable covering representations of point-, route- and survey knowledge.

The model incorporates an algorithm which evaluates the actual cognitive map and determines the landmark most appropriately serving as the next subdestination. The path finding algorithm will find the most expedient doorway to reach the subdestination even if it's not located in the adjacent room.

Both cognitive map and generalized experiences are considered and thus collaborate within the route decision making process. Consequently, agents, for instance, follow circulation rooms that lead to known landmarks or exits instead of trying to reach them via offices or store rooms.

With the use of shortest path or travel time optimization algorithms, the knowledge degree has been fixed to be comprehensive by the model itself. In contrast, the new model offers the possibility to consider arbitrary spatial knowledge degrees. However, the model does not determine how a knowledge distribution of pedestrians in a specific facility looks like. Which landmarks and connections should be incorporated in cognitive maps of visitors of a museum, for example? How familiar are first time visitors? How many workers and how many guests are present in an office building and how familiar are they?

The model cannot answer these questions. Thus, the user is responsible for the selection of appropriate knowledge degrees of every single agent. This is certainly a disadvantage as the use of the model is accompanied with additional effort for the user. However, surveys and studies help to identify the knowledge distribution of a facility's occupants. At least, if no data can be gathered, the user has to make assumptions based on experiences from other similar buildings. Beside the use of gathered data and assumptions, the author recommends to vary the knowledge distribution or rather to carry out a series of simulations that consider various conceivable knowledge degrees.

# Chapter 5

## Perception of signs

### 5.1 Miscellaneous

Many studies turned out that even though signage is close and not hidden and thus physically recognizable, a remarkable part of people do not perceive signage during evacuation (see Sec. 2.4.2). In order to consider that only a certain proportion follow signage, a probabilistic model is introduced that represents the perception of signs.

The probability that signage is perceived is influenced by a huge number of factors e.g. size and salience of the sign, layout and structure of the facility, illumination, and distracting objects. Therefore, the here presented model uses empirically determined probabilities (instead of calculating them) that are obtained from studies which apply for a specific environment and a specific sign type. Based on the probabilities the model determines if a certain sign that is physically visible is perceived by a specific agent. The second part of the model enables agents which recognized a certain sign to select the proceeding way (crossing to unexplored area) that is indicated by the sign.

### 5.2 Visibility of signs

Obviously only signs can be perceived and recognized if they are physically visible. That means, on the one hand, the sign has to be within a person's actual field of view or rather must not be hidden by any objects. Thus, agents in the simulation can only detect signs that are located within their current visibility polygon (isovist). On the other hand, signs that are too far away from a person cannot be perceived and interpreted. In this context, the alignment or the orientation of the sign towards the location of the person is important. If the sign is facing to the person directly, it

is obviously easier to see and interpret it. In contrast, it is more difficult to perceive signage from a side angle [Xie et al., 2007].

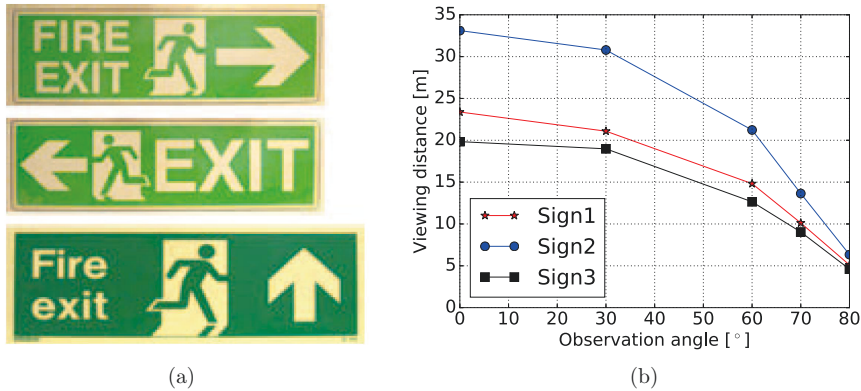

Figure 5.1: a) British exit signage that was used in the study by Xie et al. [2007]. From top to bottom: Sign1, Sign2, Sign3 b) Average viewing distance in dependency on the observation angle at which participants in the study by Xie et al. [2007] still were able to identify exit signage shown in a).

Xie et al. [2007] conducted a study in which subjects were supposed to approach an exit sign until they were able to recognize 50% of the letters on the sign. This was considered to be sufficient to identify and to understand the sign. As the sign could be identified, the distance between sign and subject has been recorded. In various experimental runs, the sign's orientation towards the participant has been varied.

Fig. 5.1(b) shows the average maximum viewing distance recorded in this study in dependency on the observation angle. This distance decreases non-linearly when the observation angle enlarges. If the value pair of viewing distance and observation angle lies underneath the curves, the according signs are, on an average, perceivable and recognizable.

This concept is directly applied for the agents in the model framework. In consequence, an agent is only able to perceive a specific sign if the respective value pair of viewing distance and observation angle is located underneath the according curve.

Exit signage is different all over the world. However, size, layout, pictograms and fontsize (if applicable) are similar in most cases. Thus, it is assumed that the maximum viewing distances at specific viewing angles are similar for various signs. In addition, in many cases signage can be identified without the necessity to read any

letters on the sign. As a conservative approximation the curve of Sign 3 is used in the implementation of the framework.

### 5.3 Probability to detect signage

The here presented model is based on the parameter  $P$  that mainly affects the decision if signage is perceived or not.  $P$  considers the general salience of signage and environmental factors in the facility but also personal attributes of a person that affects his/her willingness to use signage.  $P$  is not calculated by the model but has to be provided by the user.

It is assumed that persons who once perceived and followed a sign more likely tend to discern subsequent signs as he/she is aware of the presence and helpfulness of signage (learning effect). The more signs they perceive successively, the more likely they detect further signage. On the other hand, it is assumed that persons who disregard signage in the first place pay less attention to further signs since they rather use other wayfinding strategies or are generally less willing to use signage. The more consecutive signs they miss at the beginning, the more unlikely they perceive subsequent signage. Based on these assumptions, the probability  $P$  is decreased by  $m \cdot \eta$  for agents that failed to perceive previous signage and increased by  $n \cdot \zeta$  for agents that detected signage before (see Eq. 5.1).

$$P_i = \begin{cases} P + m \cdot \zeta & \text{if a previous sign detected} \\ P - n \cdot \eta & \text{if no sign detected yet} \end{cases} \quad (5.1)$$

$$\text{with } \eta \in (0, 1); \quad \zeta \in (0, 1); \quad m \in \mathbb{N}_0; \quad n \in \mathbb{N}_0; \quad i \in \mathbb{N}$$

The probability  $P_0$  to perceive the first sign approached by an agent equals  $P$ . For obvious reasons,  $P_i$  is restricted to be greater equal 0 and lower equal 1.

When an agent is physically able to see a sign, it is instantaneously decided whether the agent perceives the sign or not. After the decision has been made, an agent has no further possibility to detect it. Consequently, it is of no matter how long the agent has visual contact to the sign or how close it will come to it. This simplification has been done due to the following reasons. Although the distance between wayfinder and sign and the time he/she stays in the visibility range of the sign most likely has an influence, there is not enough scientific evidence to quantify this effect. Furthermore, these factors are partially considered in the determination of  $P$ . This is due to the fact that in most cases  $P$  is based on the results from studies in which realistic dwelling times in the range of signs and realistic distances between subjects and signs were utilized.

## 5.4 Implementing a sign's instruction

Once perceived a sign, an agent is implementing the instruction on the sign by selecting a crossing to unexplored area which is located on the path that is most likely indicated on the sign. In order to explain the steps that are processed in this context, the scenario in Fig. 5.2 is regarded. Here, an agent is approaching a T-junction with a preceding corridor. Three different crossings to unknown area are available at this point.

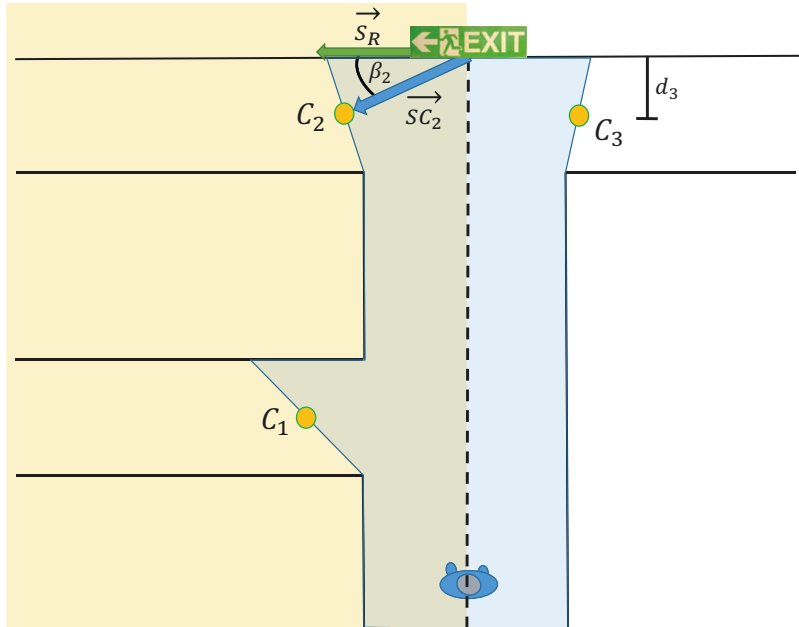

Figure 5.2: An agent is approaching a T-junction at which a sign has been installed. Three crossings to proceed ( $C_1$ ,  $C_2$ ,  $C_3$ ) are available. They are represented by their centers.  $\beta_2$  describes the angle between the vector  $\vec{S}_R$  that represents the direction indicated on the sign and the vector  $\vec{SC}_2$  that connects the sign's center and the center of crossing  $C_2$ .  $d_3$  describes the shortest distance from the center of crossing  $C_3$  to the vector  $\vec{S}_R$ .

Firstly, the path that is proposed by a sign must be on the side of the sign that is indicated by it. In Fig. 5.2 this applies for the area that is highlighted in yellow and located on the left of the dashed line. Thus, crossing  $C_3$  can be ruled out as a candidate for the indicated way. Generally, crossings which are related to an angle

$\beta_i$  (see Fig. 5.2) greater than 90 degrees are sorted out. The angle  $\beta_i$  is the angle between the vector  $\vec{S}_R$  that represents the direction indicated on the sign (green in the figure) and the vector  $\vec{SC}_i$  that connects the sign's center and the center of crossing  $C_i$  (blue in the figure).

Still two candidates are left. If multiple candidates remain eligible, the crossing that is related to the smallest distance  $d_i$  is selected finally. The distance  $d_i$  describes the shortest distance from the center of crossing  $C_i$  to the vector  $\vec{S}_R$  (straight line) that represents the direction indicated on the sign (see Fig. 5.2).

The candidates that lie on the "correct" side are ranked or rather sorted accordingly to their related distance  $d_i$ . The candidates that lie on the "wrong" side of the sign remain unsorted and are ranged at the back of the list of the previously sorted candidates from the "correct" side. If an agent's route choice decision is not influenced by any other factors, the agent uses the crossing that is the top element of this list.

### In case there are multiple signs

In certain situations, multiple signs are visible and perceived at the same time. The signs are either competing signs (signs indicate different directions) or they belong to the same chain of signs which means that one sign is pointing to the location of the successor.

Agents choose randomly between competing signs. If agents perceive multiple signs of the same chain, they are capable of identifying which of the signs are predecessors ( $S_2$  and  $S_3$  in Fig. 5.3) and which ones are successors ( $S_1$  and  $S_2$  in Fig. 5.3). Finally, the agent follows the instruction of the sign that has no successors (the first sign in the chain,  $S_1$  in Fig. 5.3).

The following procedure is used to identify the first sign in a chain of signs. For every sign in the chain, the angles  $\gamma_{i,j}$  are calculated.  $\gamma_{i,j}$  describes the angle between the vector  $\vec{S}_{iR}$  that represents the direction of the instruction on Sign  $i$  and the vector  $\vec{S}_i\vec{S}_j$  that connects the positions of signs  $i$  and  $j$ . In Fig. 5.3, the angle  $\gamma_{2,1}$  is exemplary shown.

For each sign  $i$ , the smallest angle

$$\gamma_{i,min} = \min_j \gamma_{i,j} \tag{5.2}$$

is identified. In general, the signs that are successors are related to a relatively small angle  $\gamma_{i,min}$ . This is due to the fact that they point to a successor.



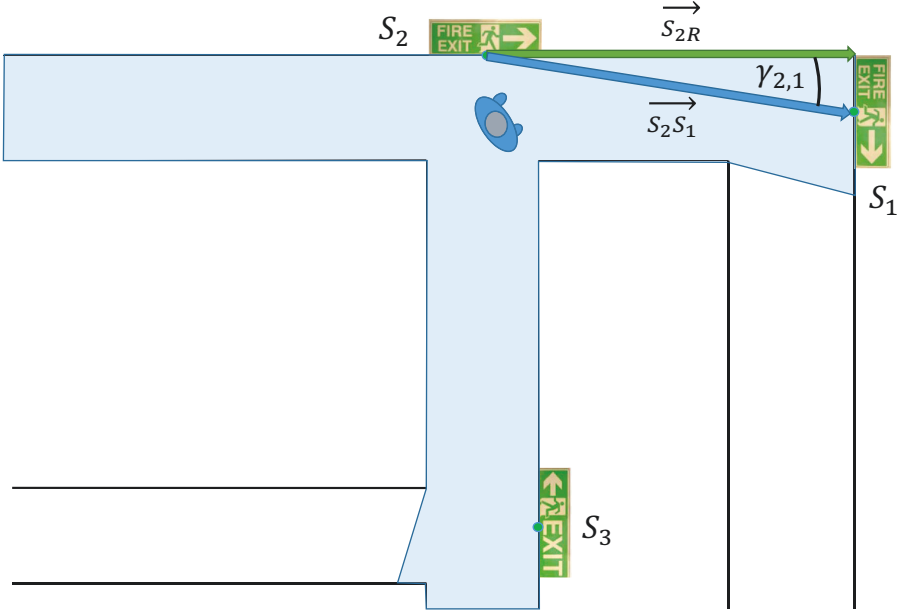

Figure 5.3: An agent is approaching a T-junction. Three signs are visible from the agent's current position.  $\gamma_{2,1}$  describes the angle between the vector  $\vec{S}_{2R}$  that represents the direction of the instruction on Sign 2 and the vector  $\vec{S}_2\vec{S}_1$  that represents the direction of the instruction on Sign 1.

In contrast, the first sign in the chain is principally related to the greatest angle

$$\max_i \gamma_{i,min}. \quad (5.3)$$

In consequence, the agent follows the instruction of the sign that corresponds to the angle  $\max_i \gamma_{i,min}$ .

There are conceivable cases in which this process does not work. For example, when  $S_1$  would be very close to  $S_2$ , it would almost point directly to  $S_3$ . However, these scenarios do not consist of a reasonable set-up of signs and are not present in real facilities. This process is expedient for all reasonable set-up of signs.

## 5.5 Example

In order to demonstrate the effects of the modeling approaches, the following scenario is regarded.

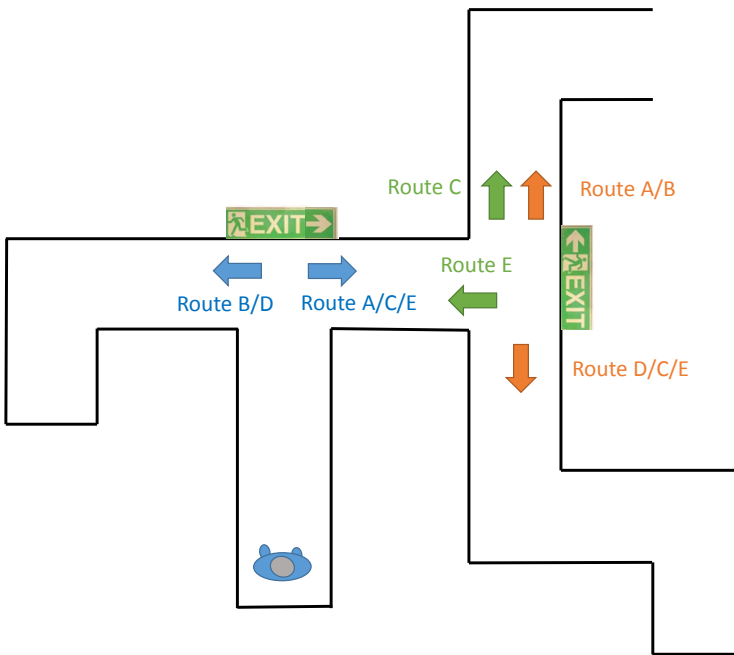

Figure 5.4: A small, fictional maze. The agent tries to find a way to the exit which is located at the upper right corner. Two exit signs are present at the two decision points.

An agent would like to evacuate from the small maze depicted in Fig. 5.4. The maze consists of two decision points. At each of the points an exit sign is present. Possible routes to the exit (including detours and turn arounds) are indicated in the figure. Route B, for example, describes the path which an agent takes if it decides to go left first, turns around at the dead end, proceeds to the second decision point, turns left and arrives at the exit finally. Route choices at the first decision point are marked with blue arrows in the figure. Decisions at the second decision point are marked orange. Agents that turn right and then right again face the dead end on the right side. Therefore, they are forced to turn around and approach the second

decision point again. Here, they again have to make a decision. They can choose to go straight ahead or turn left (marked with green arrows in the figure).

Two different scenarios are regarded. In both scenarios agents are supposed to decide randomly unless their route choice is affected by one wayfinding tool at least.

In the first scenario (Scenario A) it is assumed that the probability  $P$  that signage is perceived and followed equals 0.5. The parameters  $\eta$  and  $\zeta$  equal 0.5 as well. Thus, only two cases can occur: The agent perceives the first sign so that the probability  $P$  increases by 0.5. Consequently, subsequent signs will be perceived as well. In the second possible case the agent fails to perceive the first sign and thus also fails to perceive the second one as the probability  $P$  has decreased to zero. The agent is not provided with any other wayfinding tools.

In Scenario B the probability to perceive signage is zero ( $P = 0$ ). Other wayfinding tools are not provided to the agent either. Hence, the agent decides randomly (between the not already explored paths) at each of the decision points. This scenario serves as a comparison to Scenario A.

## Results

500 simulation runs of each of the scenarios lead to the route distribution depicted in Figs. 5.5(a) and 5.5(b). Fig. 5.5(b) shows the route distribution that results if the agent selects randomly (Scenario B). The percentage of runs in which the agent took Route A, B or C is approximately equal. The frequency of runs in which the agent selected Route C and E is about half the size since on these two routes a third decision had to be made. Here, a route is separated into two routes again.

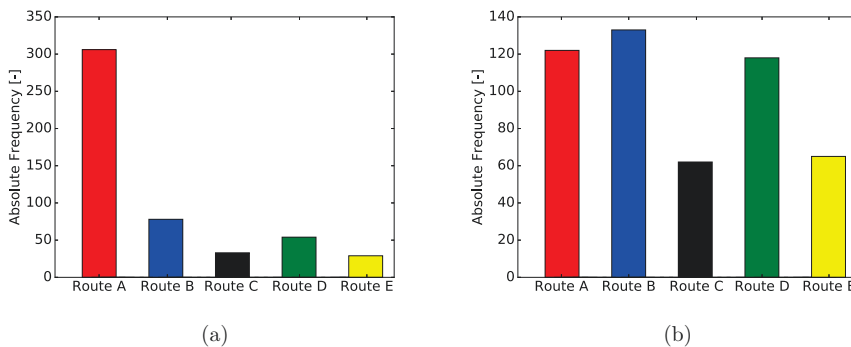

Figure 5.5: a) Route distribution of Scenario A. b) Route distribution of Scenario B.

In Scenario A, the agent selects randomly in ca. 50 % of the runs as it fails to detect signage in these cases. Consequently, these runs yield to the same route distribution that resulted in Scenario B. In the remaining runs the agent follows both signs (Route A). Hence, the total distribution of Scenario A is dominated by the use of Route A.

## 5.6 Summary and discussion

The following flow chart (Fig. 5.6) provides an overview over the steps being executed within the modeling approach. The here shown procedure is executed for each of the signs in the building and in every timestep in which the agents' isovists are updated. First, if signs are physically visible, a random number generator is used to determine whether an agent perceives the regarded signs. If necessary, the first sign among a chain of multiple detected signs is identified. Subsequently, the crossing to unknown area that complies best with the instruction on the decisive sign is determined and used as the next subdestination on the frontier (to unexplored area) (see Sec. 5.2).

The percentage of persons who perceive signage is dependent on a huge number of factors e.g. properties of sign, environmental factors, personal attributes. That is why the model refrains from predicting it. Instead, it uses given probabilities from the literature or studies' results. The great disadvantage of this is that the model parameters need to be calibrated for every specific situation or rather environment (incl. signs and environmental factors). A calibrated value for the model parameter  $P$  is demonstrably no longer valid if the sign properties alter, even in the same environment (cf. Xie et al. [2007] static signage: 39 % detect signage - Galea et al. [2014] dynamic signage: 77 % detect signage). Even within a single environment which comprises similar signs, each of the choice points are at least slightly different or rather possess different environmental factors that influence the perceptibility of signage. Furthermore, the perceptibility can be affected by personal attributes of the persons in the facility. Particularly, the persons' knowledge degrees can play a major role in this context.

The model considers that persons who used signage before are more likely to use further signs. However, it does not consider people who got lost, realized that their previously chosen wayfinding strategy was not expedient and thus decide to look for signage. For these reasons, the here discussed model, even though calibrated for a specific situation, can only approximately determine the influence of sign usage on the route choice distribution.

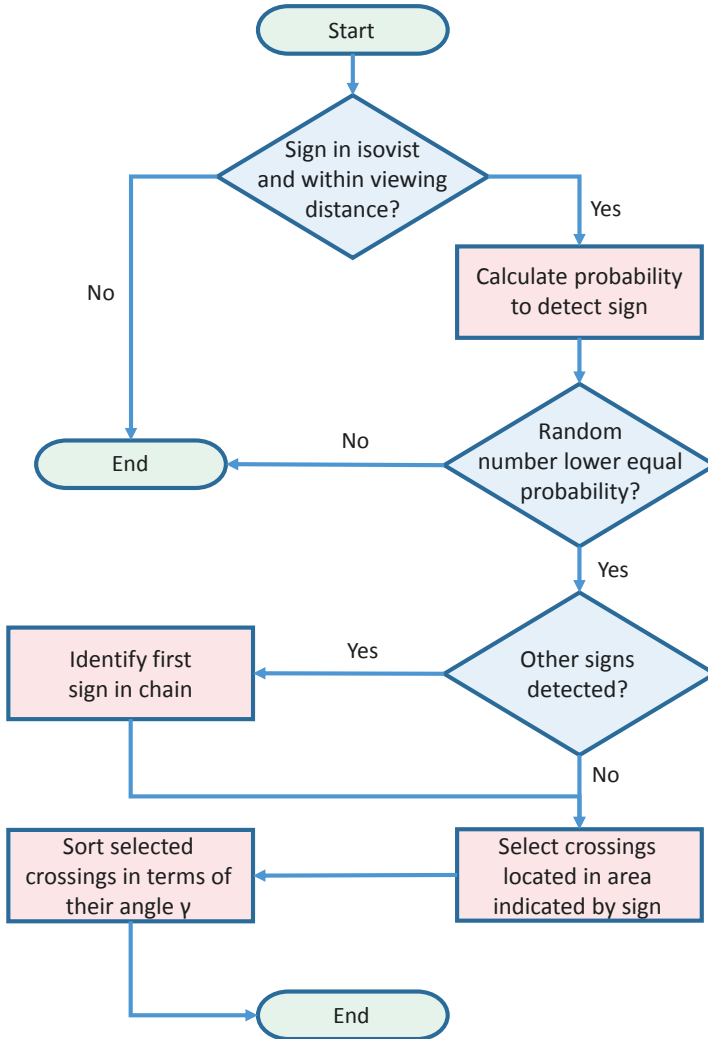

Figure 5.6: Procedure 6: Procedure to find the crossing to unknown area that serves best to follow the instruction on a perceived sign.

# Chapter 6

## Summarizing the cognitive framework

### 6.1 Combination of single parts

Fig. 6.1 summarizes what has been introduced so far in the context of the model framework. Therefor, it shows all involved parts and steps in the wayfinding process of an agent. Particularly, the figure shows how a reasonable proceeding crossing to unknown area and subsequently a visible crossing is selected considering the cognitive map, generalized knowledge and signage.

First of all, crossings to unexplored area are identified from the short term memory polygon and stored in a list. In dependency of the chosen search strategy, this list is then either shuffled or sorted under consideration of the nearest door heuristic. Subsequently, the list is sorted taking into account information from the cognitive map (see Sec. 4.1.2), generalized knowledge (see Sec. 4.2) and possibly signage (see Sec. 5.4). The order of the sorts determines which of these factors overrules the other factors. The implemented hierarchy of the factors is generalized knowledge - signage - cognitive map.

In consequence, available crossings are sorted considering information from the cognitive map first and subsequently resorted considering signage. Thus, the sort based on signage is decisive as it is executed after the first sort. That means, the crossing which is indicated on a sign is selected by an agent even though it knows about an alternative path in its cognitive map. Though, it is possible to reduce the probability  $P$  for agents representing familiar persons so that they are less likely to perceive and follow signage. In this case, it is assumed that they don't need any help from signage on their familiar path and are therefore less willing to look for and use signage.

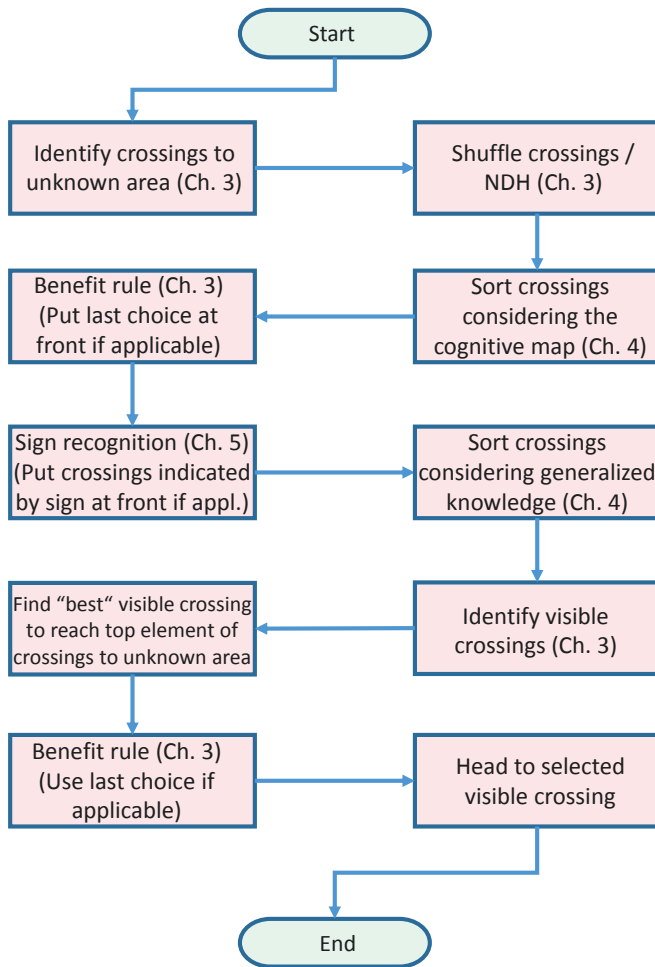

Figure 6.1: Procedure 7: Procedure of the combined model framework. First a crossing to unknown area is selected under consideration of the cognitive map, exit signage and generalized knowledge. Subsequently, a visible crossing is identified that serves best to reach the previously chosen crossing to unknown area.

Both sign instruction and generalized knowledge are taken into account by agents so that proceeding corridors are selected that are located in the area indicated by the sign. Accordingly, a crossing that is indicated by a sign will stay at the top of the

list of crossings if it also leads to a circulation room. However, rare situations are conceivable where generalized knowledge disagrees with signage. This happens, for example, if no circulation room is present that is located in the indicated area and the sign therefore clearly leads to a common room. In these situations, it is assumed that generalized knowledge has a higher influence on the route decision. In consequence, the instruction on the sign is not followed.

Eventually, the crossing that is found at the top of the list of crossings to unknown area after all sorts is considered as the final choice. Subsequently, a visible crossing is identified that serves best to reach the previously selected crossing to unexplored area.

## 6.2 Implementation

Essentially, the C++ implementation of the above described approaches consists of three C++ classes (see Fig. 6.2).

The central part of the framework is the class "Cortex". An object of this C++-class is provided with evaluated spatial memories and with information about the currently visible and already explored environment incl. its objects (signs) and properties (room type). The task of the class Cortex is to weigh the gathered information and to make a final decision in terms where to go to in the next step (which is accomplished by the above described sorting procedure). Subsequently, the Cortex hands over the decision in form of a visible crossing to the JPscore module.

An object of the class "CognitiveMap" represents the human cognitive map. It stores and evaluates spatial relations of the own position, landmarks and destinations.

Given a list of crossings, such an object sorts the list in consideration of the set-up of visited and non-visited landmarks in the cognitive map. Subsequently, it returns the sorted list to the Cortex.

The "VisualSystem" stores and evaluates both isovists representing the already explored and the currently visible spatial environment. It identifies possible crossings to proceed and hands them over to the Cortex. Furthermore, it provides the Cortex with perceived signs and room types and informs the CognitiveMap if a landmark is visible.

An object of the class "VisibleEnvironment" processes the spatial structure which the object obtains from JPscore. Based on the obtained structure, the object generates isovists so that the environment can be evaluated by the VisualSystem.



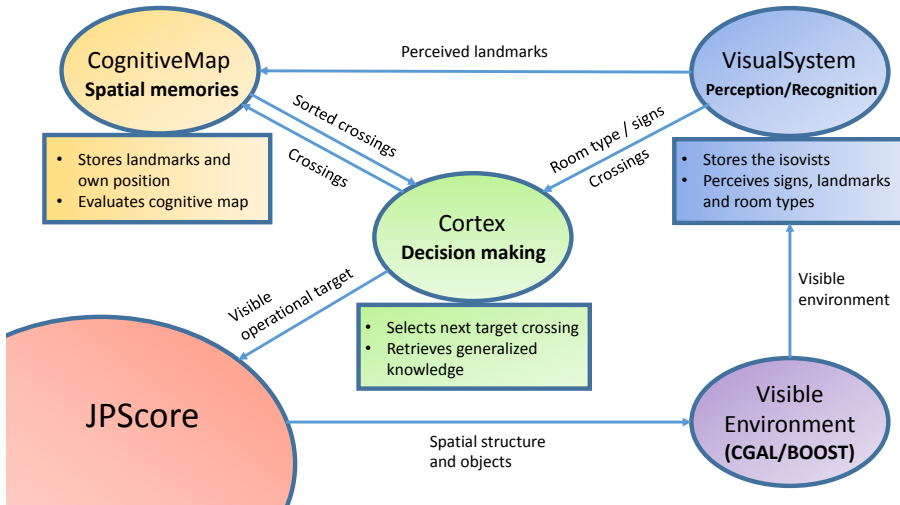

Figure 6.2: Interaction of the involved classes in the entire model framework.

## Class relations

To guarantee a working flow of information between all parts of the framework, the following class relations are used (see Fig. 6.3).

The "JPS-AI-Framework" is encapsulated (as best as possible) and can only be reached via the class "Router" from the previously existing code of JPScore. Beside this interface, the AI framework only catches information from instances of the classes "Pedestrian" and "Building". Both connections are accomplished by using const-pointers which only allow read-access or rather forbid the JPS-AI-Framework to overwrite or change something outside of the framework.

The Router is responsible for the route choices of the pedestrians. Therefore, it possesses a container of instances of the class Cortex. Each instance is associated with an instance of the class Pedestrian (each pedestrian is linked to its individual Cortex). In order to accomplish the association, a Cortex is provided with a (const)-pointer to a pedestrian.

It might be more intuitive to provide a pedestrian with a cortex as a member data. However, JuPedSim's development concepts dictate that routing tasks should be outsourced to the router class. In principle, in JuPedSim, instances of the class Pedestrian should mainly store the pedestrians' attributes instead of executing their actions.

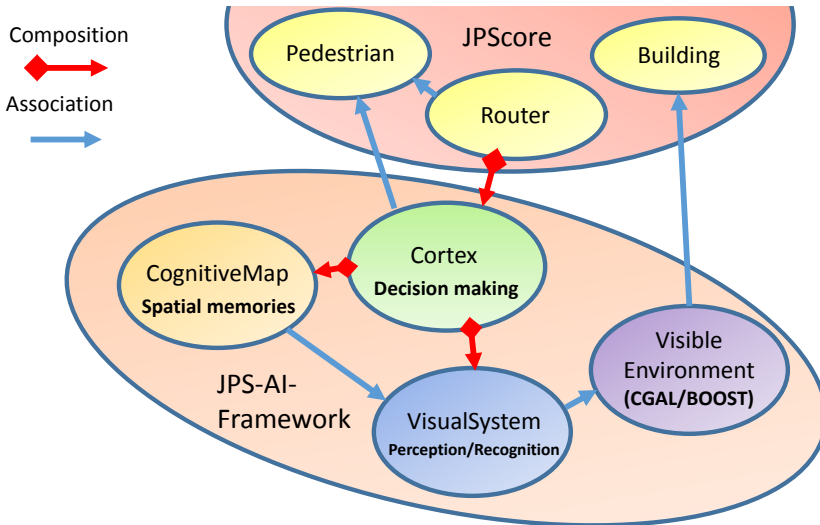

Figure 6.3: Class relations of classes that are part of the JPS-AI-Framework and their connections to classes of JuPedSim.

Each object of the class Cortex possesses an instance of CognitiveMap and VisualSystem. The CognitiveMap is provided with a const-pointer to the VisualSystem so that it is able to ask the VisualSystem whether landmarks are in sight.

The class VisibleEnvironment possesses a pointer to the class Building since it needs information about the spatial structure of the facility.

The VisualSystem has a const-pointer to the VisibleEnvironment in order to be able to evaluate the environment and to perceive landmarks, signs and room types.



**Part III**

**Experiments and Model  
Calibration**

---

# Chapter 7

## Wayfinding studies in an office building

NOTE: Major parts of this chapter (contentwise but partially also word-for-word) have already been published in Andresen et al. [2018].

### 7.1 Miscellaneous

The author and his colleagues conducted a field study in a building of the Research Centre Jülich. The main goal of the study was to investigate the route choices of people in dependency on their spatial knowledge degree about the building. Furthermore, the study has been carried out to obtain data that can be used to calibrate and test the cognitive map model discussed in Chapter 4.

### 7.2 Method

The study took part on the second floor of the building. The spatial structure of this floor is depicted in Fig. 7.1. The floor is used (as well as the other parts of the building) for office purposes. During the experimental runs the emergency exit signs were covered to exclude the influence of signage on the route choices. Only the signage which was directly installed on exit doors were kept.

#### 7.2.1 Participants

47 persons participated in the study. 23 of them were female, 24 male. The ages of the participants were between ca. 20 and ca. 70 years. The average age was approximately 35 years. All participants were healthy and not physically impaired. They had no visual impairment or wear glasses to correct a visual impairment. The

group of subjects mainly comprised either students or employees from the Research Center Jülich. The participants signed an informed consent agreeing to the record of their data. Data has been recorded anonymously and is used for scientific purposes only.

The subjects participated individually (sequentially). Beforehand, they were asked to fill a brief questionnaire. Beside gender and age the subjects were supposed to rate (from 1 to 10) their knowledge degree or rather their familiarity with the building. The number of participants who ranked themselves into a certain familiarity level is shown in Tab. 7.1.

Table 7.1: Results of the questionnaire: Self-rated familiarity of the participants.

Knowledge degree	1	2	3	4	5	6	7	8	9	10	Total
Number of subjects	5	3	3	4	2	1	7	13	5	4	47

### 7.2.2 Task

Sequentially, the participants were led to the starting point. They were guided via Balcony E (see Fig. 7.1) so that they could not see any part inside the building before the start of the study. At the starting point the task has been explained to a subject by the experimenter. The task incorporated the following points:

1. The participants were supposed to assume that they were in a situation of a hazard (for example a fire) and an announcement to leave the building has been given.
2. It was not allowed to use Balcony E or F for the evacuations. The subjects were told that these exits were blocked for some reason (collapse, fire, smoke, etc.)
3. The subjects were told not to run but walk normally.

For documentation purposes the experimentees were asked to wear a headband on which a video camera has been installed.

Fig. 7.1 shows the routes the subjects could have used to fulfill their task, namely to evacuate from the building (considering the conditions mentioned above). It has been assumed that nobody will try to evacuate by moving into a store room or an office due to generalized knowledge about office layouts. Consequently, the possible routes have been determined by considering the corridors, foyers and stairs without exception.

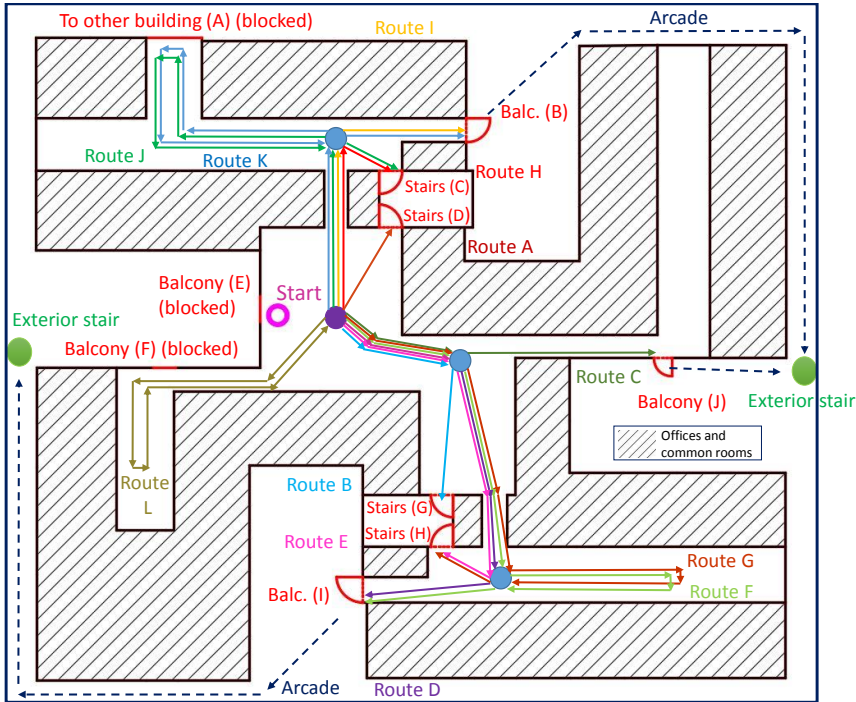

Figure 7.1: In the background: The floor plan of the area which was used for the field study. In the foreground: All possible routes the subjects could use.

Routes A and B lead immediately to the staircases (Stair D or Stair G). Route C leads to Balcony J which can be seen on the right side of the floor plan. The crossing to Balcony J is not visible from the starting point. In fact, it only can be seen from a close position in front of it (see Fig. 7.2(a)). Each of the routes D,E,F,G,H,I,J,K lead either to the corridor at the upper or at the lower side of the ground plan. Within these corridors one either can go immediately to one of the balconies B or I (Route I or Route D) or immediately to the staircases C or H (Route H or Route E). Alternatively, it is possible to explore the corridors first and to proceed to a balcony or staircase (routes F,G,J,K) subsequently. Both mentioned corridors possess pillars and furniture that hide the view of the whole corridor from several positions, so that explorations into the corridors had been expected.

In connection to the upper corridor there is a possibility to proceed to another building (A). During the study the crossing to the neighbor building has been blocked. Subjects who wanted to pass here had to turn around and look for other options to evacuate. Route L describes the path from the starting point to the left corridor



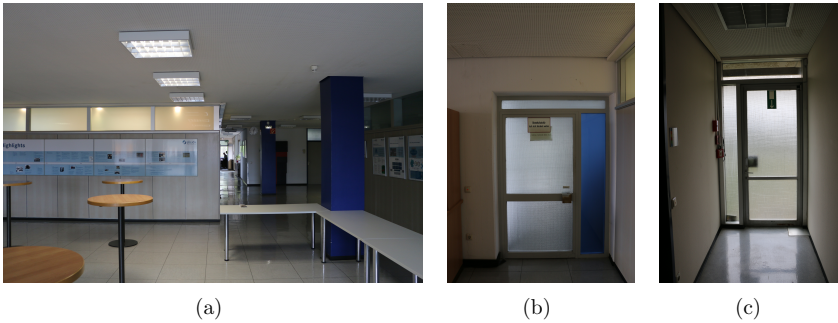

Figure 7.2: a) View from the starting point towards the corridor on the right side of the floor plan. b) Crossing that leads to Stair D. c) Crossing that leads to Balcony B.

on the floor plan. It was not explicitly forbidden to use the left corridor. However, Balcony F was blocked. Thus, participants who went here had to move back to the foyer where the starting point was. Back in the foyer they had to start their journey again and decide for one of the other mentioned routes. As only one subject took Route L, it is not considered which route has been taken after the subject came back to the starting point. In consequence, all routes that starts with a journey to the left corridor are regarded as Route L.

Each of the doors that either lead to one of the balconies or one of the staircases consists of non-transparent but translucent glazing (see Fig. 7.2(c)). The door at Balcony J is an exception. It consists of transparent glazing. Doorways that lead to staircases are not furnished with signs (see Fig. 7.2(b)). Doorways to the outside are provided with green exit signs (see Fig. 7.2(c)) which were not covered (in contrast to the rest of the signage in the building).

Via one of the staircases it is possible to move downstairs and proceed via a corridor to find a final exit on the ground level. Alternatively, participants could use one of the exterior staircases to reach the ground level. These staircases are directly accessible via balconies J and E/F. From balconies B and I they can be approached by following the exterior arcade that leads around the second floor of the building.

For reasons of simplification, in this work, the route choices on the second floor are regarded without exception.

### 7.3 Results

Tab. 7.2 shows the route usages that resulted from the field study. Particularly, the table mentions how the subjects who took a specific route rated their own knowledge degree. For example: 3 participants who rated their knowledge degree with the value 8 took Route C (see row 5 / column 9 of Tab. 7.2).

It is clearly visible that the route usage of participants that possessed a minor knowledge degree (1 - 5) comprises the use of more different routes (8 routes) in comparison to the route usage of the familiar participants (6-10) (3 routes). One participant of those who classified their knowledge degree in the interval from 1 to 5 took Route A, five took Route B, another four used Route C, one Route G, one Route J, two Route K and another one Route L.

Table 7.2: Distribution of route usage: Number of participants that took a specific route in consideration of their self-rated knowledge degree. The average knowledge degree is about ca. 6.1.

Route / Knowledge degree	1	2	3	4	5	6	7	8	9	10	Total
Total number	5	3	3	4	2	1	7	13	5	4	47
Route A	—	—	—	—	1	—	4	7	1	—	13
Route B	—	2	1	2	—	1	1	3	1	—	11
Route C	2	1	—	1	—	—	2	3	3	4	16
Route D	1	—	1	—	—	—	—	—	—	—	2
Route E	—	—	—	—	—	—	—	—	—	—	0
Route F	—	—	—	—	—	—	—	—	—	—	0
Route G	—	—	—	—	1	—	—	—	—	—	1
Route H	—	—	—	—	—	—	—	—	—	—	0
Route I	—	—	—	—	—	—	—	—	—	—	0
Route J	—	—	1	—	—	—	—	—	—	—	1
Route K	1	—	—	1	—	—	—	—	—	—	2
Route L	1	—	—	—	—	—	—	—	—	—	1

From within the upper and lower corridor one can see the exits to Balcony I or rather Balcony B. Nevertheless, here, 3 participants decided to go left and were forced to turn around due to the dead end. It is conceivable that these participants made their route choice decision and headed left before the exits were visible. Another possible explanation comprises the supposition that they saw the exit doors but could not identify them as doorways to the outside.

Even though the route usage of unfamiliar subjects varies, the results listed in Tab. 7.2 show a slight preference for Route B (5 subjects) and Route C (4 subjects).

On the one hand, these subjects simply might have known these paths although they rated their overall knowledge about the building to be minor. On the other hand, the preference might have turned out because some participants were attracted by the brightness of the corridor next to Balcony J. Besides, also the wideness of the foyer that is contiguous to the starting area might have attracted the subjects.

Although the usage of Route L was allowed, only one subjects decided to take this route. This might be caused by the fact that the experimenters told the participants that Balcony E or F are not usable for the evacuation. Consequently, the participants mainly preferred to head to directions moving away from the blocked balconies.

Participants who were familiar with the building took one of the routes A, B or C without exception. This clearly shows that spatial knowledge has a remarkable influence on the participants' route choice decisions. The high proportional usage of Route A and B (via stairs) can be explained based on the fact that the staircases are commonly used to enter and leave the second floor either from or to workplace, to administrative offices or meeting rooms. In fact, a number of participants stated after they left the building that they evacuated via the path they commonly use for any purposes and know for sure. They might have known about other routes as well but felt more comfortable using their daily path. Route C which is the shortest path to get to the outside (and to the ground level) has mostly been taken by subjects with profound knowledge about the building. All four subjects who claimed their knowledge to be comprehensive (value 10) used Route C without exception. This fact suggests that only people who are very familiar with their spatial surroundings and are confident to evaluate and compare different routes in the context of their length and travel duration take the shortest path.

## **7.4 Calibration by comparing route distributions from field study and simulations**

### **Preliminary considerations**

In this section, the results of the field study are used to calibrate the cognitive map model that has been introduced and discussed previously in this work. It is shown that the model is able to reproduce the route distribution that resulted from the field study with minor deviations. For this purpose, the route distribution of the calibrated model is compared to the distribution of the field study. In addition, route usages that resulted when using a shortest path algorithm, the nearest door heuristic, and randomly made decisions are also regarded for comparison purposes.

Each of the participants in the study only used circulation rooms. Thus, for the model calibration, agents in the simulation are provided with generalized knowledge so that all of them prefer to use circulation rooms. In general, regardless of the used routing model the decisions are always restricted to circulation rooms.

The outcomes of the study suggests that the subjects mainly failed to identify doors that lead to the balconies or to the staircases. Otherwise the routes that lead directly to stairs or balconies would have been used more frequently by unfamiliar subjects. For this reason, exit doors and doors to stairs are treated as corridors for this calibration. Consequently, agents do not favor stairs and exit over circulations rooms. If wayfinding tools do not provide any information, the agents randomly choose between the possibilities to proceed.

In the context of the calibration of the cognitive map model the most decisive question is how the subjects or rather their knowledge degrees can be represented by simulated agents or rather their cognitive maps. To address this question, the following premises are considered:

- Agents that represent subjects who are absolutely familiar with the building are supposed to be provided with a comprehensive cognitive map that includes all relevant landmarks (here all relevant rooms and exits) and possible connections between them. The positions of these landmarks are accurate so that the agents are able to evaluate and favor routes that are shorter. This means, that the elliptical representations of the landmarks are within the respective corridors or are not shifted from the respective exits. Furthermore, the dimensions of the ellipses do not exceed the dimensions of the respective corridors. The comprehensive map is depicted in Fig. 7.3.
- Participants who rated their knowledge degree with the value 1 are assumed to be first time visitors. Thus, respective agents are supposed to be provided with an empty cognitive map.
- Agents that represent subjects who claimed to have some but not comprehensive information shall obtain partially filled cognitive maps or rather cognitive maps in which specific landmarks and their connections are omitted.
- For the reason of simplification positions, shape, and size of landmarks are not changed. Only the number of landmarks in the maps is varied. Additionally, all connections between existing landmarks are kept.

**Calibration**

Fig. 7.3 describes the cognitive map of an agent with comprehensive spatial knowledge. Main destinations A and B represent the entrances of the building on the ground level or the exterior staircases that are located next to the entrances. Main destination C depicts the entrance of the neighboring building. As this entrance is too far away from the other landmarks and the area of the study, the entrance’s position is not shown explicitly in the figure. The remaining landmarks depict the positions of corridors and staircases that are relevant and useful for the evacuation task.

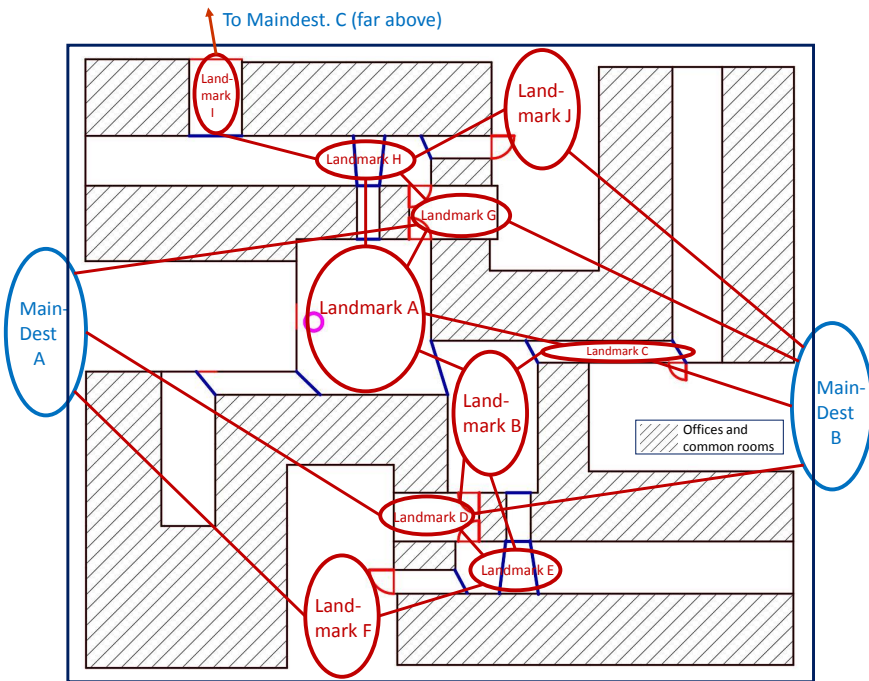

Figure 7.3: In the background: The floor plan of the area which was used for the simulation cases. Red lines depict final exits. In the foreground: Landmarks and main destinations that are incorporated in a cognitive map that represents comprehensive spatial knowledge.

To create cognitive maps for groups of agents with different knowledge degrees, a specific proportion of landmarks and/or main destinations are randomly removed from the map.

The remaining question is how many percent of landmarks have to be removed to describe the knowledge degrees of specific groups of subjects appropriately (for

example the group of persons that rated their knowledge with the value 8). To address this question, a function is used to describe the relation between the group's knowledge degree  $k$  and the percentage of randomly removed landmarks. In this case, the proportion of randomly removed landmarks equals the probability  $P(k) \in [0, 1]$  that a certain landmark is removed. The probability  $P(k)$  applies for all landmarks, thus all landmarks are treated equally. For reason of simplicity a linear function is used (see Eq. 7.1).

$$P(k) = m \cdot k + P_0; \quad m, P_0 \in \mathbb{R} \quad (7.1)$$

For example, for a cognitive map of an agent with the knowledge degree 6,  $(6m + P_0) \cdot 100$  percent of the landmarks are preserved. To find the pair of parameters  $m$  and  $P_0$  which is most appropriate to describe the relation between self-rated knowledge degree and part of removed landmarks, the following procedure is applied.

470 simulations<sup>1</sup> of the field study's scenario for a specific pair of parameters are conducted. The simulations are carried out with the help of JuPedSim. In every simulation run a single agent starts at the position from which also the subjects in the study started and attempts to evacuate. The used geometry set-up is shown in Fig. 7.3.

Within a certain part of the 470 simulation runs for every parameter pair, a single agent is equipped with a cognitive map that is described by the linear function and represents a specific knowledge degree. The relative share of runs with a certain knowledge degree corresponds to the relative part of subjects of the study with the respective knowledge degree. For example, 5 participants ( $\approx 10.6\%$ ) rated their knowledge with the value 1. Thus, 10.6% of the runs (50 runs) are carried out using an agent provided with a cognitive map that describes the knowledge degree 1. The agent's route is recorded in every run. Subsequently, the route distribution that resulted from the whole set of 470 simulation for a specific parameter pair is determined. The routes that have been considered in the evaluation of the field study are regarded as well. The route distribution is then compared to the distribution that resulted from the field study. Therefor, the percental deviation of the usage for every route is calculated. Finally, the average deviation of route usages is determined.

For the slope  $m$  the values 0.025, 0.050, ..., 0.3 are considered. It is assumed that values beyond this interval do not lead to realistic route distributions as the slope is either to steep or to gentle to describe the influence of the knowledge degree appropriately. These values are each combined with 10 values for the parameter  $P_0$

---

<sup>1</sup>A multiple of 47 (47 subjects) is used to obtain more data from the simulations and to rule out route usages that result by coincidence

## 7.4. CALIBRATION BY COMPARING ROUTE DISTRIBUTIONS FROM FIELD STUDY AND SIMULATIONS

Table 7.3: Comparison of route usages that resulted from the field study and from simulations considering various route choice models. CMap = The cognitive map approach, SP = Shortest Path, Rd. = Random choice model, NDH = Nearest door heuristic. Values in the table describe the proportion of participants and agents that used a specific route. Values are given in percent.

•	Study	CMap	Dev.	SP	Dev.	Rd.	Dev.	NDH	Dev.
Route A	27.66	31.06	3.4	0.0	27.66	24.66	3.0	0.0	27.66
Route B	23.4	5.32	18.09	0.0	23.4	8.72	14.68	0.0	23.4
Route C	34.04	36.17	2.13	100	65.96	8.09	25.95	0.0	34.04
Route D	4.26	0.85	3.4	0.0	4.26	2.06	2.2	0.0	4.26
Route E	0.0	0.85	0.85	0.0	0.0	2.21	2.21	0.0	0.0
Route F	0.0	0.64	0.64	0.0	0.0	1.89	1.89	0.0	0.0
Route G	2.13	1.7	0.43	0.0	2.13	2.41	0.28	0.0	2.13
Route H	0.0	1.91	1.91	0.0	0.0	6.39	6.39	0.0	0.0
Route I	0.0	1.91	1.91	0.0	0.0	5.96	5.96	0.0	0.0
Route J	2.13	2.13	0.0	0.0	2.13	6.1	3.97	0.0	2.13
Route K	4.26	7.66	3.4	0.0	4.26	6.45	2.19	0.0	4.26
Route L	2.13	9.79	7.66	0.0	2.13	25.06	22.93	100	97.87
Avg. Dev.	-		3.65		10.99		7.64		16.31

starting with  $-7.0 \cdot m$  followed by  $-7.0 \cdot m + \frac{1}{9}$  followed by  $-7.0 \cdot m + \frac{2}{9}$  and so on. Hence, in total 120 parameter pairs are regarded.

The pair of parameters that leads to the lowest average deviation  $\bar{dev}_{min}$  of the route distribution is considered to be the best choice to describe the relation between knowledge degree and number of preserved landmarks (see Eq. 7.2).

$$\bar{dev}_{min} = \arg \min_{m, P_0} \bar{dev}(m, P_0) \quad (7.2)$$

After the execution of the  $120 \cdot 470$  simulations, the pair consisting of the parameters  $m = 0.25$  and  $P_0 = -1.19444$  turned out to be the best choice. The comparison of the route usages are shown in Tab. 7.3.

As mentioned, route distributions that result from simulation runs using other selected route choice models are compared as well. A shortest path algorithm (SP), the nearest door heuristic (NDH), and randomly made decisions (Rd.) are selected.

The random choice model does not consider varying knowledge degrees, every agent possesses no spatial knowledge at all. Hence, the model underestimates the usage of Route A and especially Route B and Route C. Particularly, these routes were chosen by familiar subjects in the study. The usage of Route L is overestimated. Participants of the study avoided to proceed via the left corridor next to the blocked

balcony as they were told that balconies E and F were blocked. The average deviation from the usage of the field study is about 7.66 %.

SP and NDH are deterministic approaches. As the agent always starts at the same position in each of the simulation runs, it always chooses the same route when considering one of these approaches. Route C describes the shortest path, thus it's taken by 100 % of the agents when using a shortest path algorithm. In consequence, the usage of Route C is overestimated and the usage of every other route is underestimated as long as the route has been chosen at least once in the study.

Under consideration of the NDH the agent will head to the left corridor in each run as the related crossing is located closest. Hence, Route L is chosen by 100 %.

The deviations of the usages of both the SP (10.99 %) and the NDH (16.31 %) are even greater compared to the deviation of the random choice model. The greater deviations are caused by the fact that SP and NDH do not imply any variations according to agents at all.

The cognitive map approach does consider variations of spatial knowledge degrees between persons and consequently reproduces the route usage with a smaller error compared to all other listed route choice models<sup>2</sup>. Especially the usage of Route A and Route C are reproduced with a lower error (under 4 %) compared to other route choice models. Only the predicted usages of Route B (underestimated by 18.09 %) and Route L (overestimated by 7.66 %) deviate with an error larger than 4 %.

The deviation of Route L might be caused by the fact that the participants of the study were told about the blocked balconies E and F and thus avoided paths that lead into the direction of these balconies. This influence has been exerted by the experimenters. This effect is not considered in the model and thus cannot be reproduced. The overestimation of the usage of Route B might be explained by the following. On the one hand, a relatively high number of the unfamiliar subjects took Route B despite their lack of spatial knowledge. This number is higher than the number that would result when the paths are randomly chosen. Possibly these subjects preferred to go first to the other foyer as they were attracted by the size of the room or by the brightness of its adjacent corridor. Attractions such as mentioned above are not considered in the model and thus cannot be reproduced. On the other hand, the part of familiar participants that took Route B in the study is underestimated by the model as well. This is caused by the fact that agents in the simulation that know both Route A and Route B always choose Route A due to its shorter length. The

---

<sup>2</sup>The route distribution of the cognitive map approach in dependency on the knowledge degree of the agents is shown in Appendix A in detail



estimation of path lengths is not absolutely accurate in the model. Randomly chosen points within the ellipses are used to calculate the lengths of paths. Nevertheless, it is obviously accurate enough so that Route A is favored over Route B in every case. The subjects of the study might not be able to evaluate the path lengths with the necessary precision or even did not try to evaluate the lengths. They rather used the first known route that came to their mind. The prediction of the relative usage of routes A and B possibly changes if size and shape of the ellipses that represent the position of the landmarks are varied. Consequently, the calculation of path lengths would become more inaccurate.

The average deviation from the route usage of the field study is about 3.65 % when using the linear function  $P(k) = 0.25 \cdot k - 1.19444$  (see Fig. 7.4(a)). The course shows that agents that possess knowledge degrees lower than 5 are not provided with any landmarks at all. Cognitive maps of agents with a knowledge degree higher than 8 are comprehensive and contain all relevant landmarks and connections. Remaining agents are provided with partially filled cognitive maps. The part of preserved landmarks is given by the linear function.

### Priority for specific landmarks

The function only determines the proportion of preserved landmarks but does not give information about the question which landmarks are supposed to be incorporated in this part. In the above shown calibration, the selection of kept landmarks has been done randomly. Consequently, all landmarks have been treated equally in the context of the question if a specific landmark shall belong to the part of preserved ones. Another reasonable procedure comprises the introduction of a priority for certain landmarks. For instance, it can be reasonable to privilege landmarks that are more salient than others or are located on paths that are more frequently used than other routes.

Therefore, the above explained calibration approach has been done again considering a privilege for the landmarks A, B, D, G and main destinations A and B. These landmarks are located on paths that are most frequently used by workers to get to their workplaces. The mentioned landmarks and destinations are selected to be kept by a probability that is twice as high compared to other landmarks or destinations.

Under consideration of these privileges the use of the linear function with the parameter pair  $m = 0.3$   $P_0 = -1.6555$  leads to the smallest average deviation of route usages in comparison to the results of the field study. In Fig. 7.4(b) the relation between knowledge degree and probability to keep a certain non-privileged landmark

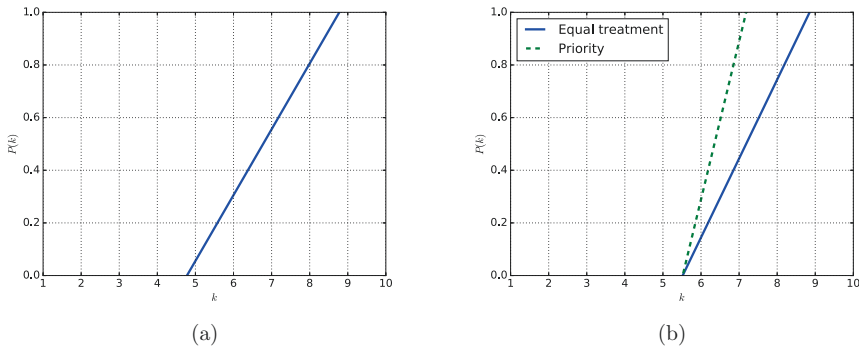

Figure 7.4: Relation between knowledge degree  $k$  of an agent and probability  $P(k)$  that a landmark or main destination is incorporated in its cognitive map. a) All landmarks and main destination are treated equally. b) The probability (green dashed line) that landmarks A, B, D, G and main destinations A and B are preserved is twice as high in comparison to the probability of other landmarks or main destinations (blue line).

is shown by the blue line. The relation between knowledge degree and probability to keep a privileged landmark is depicted by the green dashed line. The average deviation is about 3.794%, thus higher than the average deviation that resulted from the first calibration approach that does not consider any priority.

## 7.5 Summary and discussion

In this chapter, the results of a field study conducted in an office building have been discussed. Purpose of this study was to investigate the participants' route choices in the building in dependency on their knowledge degree. The field study has shown that route choices can be remarkably influenced by the familiarity of a building's user or visitor. Certain routes could be identified in the study that were particularly preferred by subjects who were familiar with the spatial structure. Almost all subjects with comprehensive knowledge about the building took the shortest path. A majority of the participants who work in the building but do not know or could not evaluate the shortest path took familiar routes e.g. routes they daily use to reach their workplace. Unfamiliar participants possibly chose their routes randomly or were attracted by brighter or greater corridors.

With the help of the approaches to model partial and inaccurate knowledge that have been introduced in this thesis, it has been attempted to reproduce the route

usage that resulted from the field study. For this purpose, different cognitive maps to model spatial representations of various knowledge degrees have been created. These maps have been established by removing a certain part of landmarks and destinations from a comprehensive map. A comparison showed that the route usage predicted by the calibrated modeling approaches are in good agreement with the route usage of the study. The average deviation is about 3.65% and thus remarkably lower than deviations that appear when using random route choices, the nearest door heuristic or a shortest path algorithm. The good agreement is mainly caused by the fact that the new modeling approaches consider the existence of partial spatial knowledge. However, the usage of one route is seriously underestimated. This deviation is possibly caused by the inability of the model to consider attractions by environmental factors.

It has been shown, that the model is an appropriate tool to reproduce the route choice distribution of the here presented field study. Nevertheless, a generic applicability of the model to predict route choices in arbitrary buildings has not been tested yet and is therefore not guaranteed. In addition, it is not assured that the model is able to predict route choices of pedestrian groups that are mainly unfamiliar with the facility, for example first time visitors.

# Chapter 8

## Wayfinding studies in a subway station

### 8.1 Miscellaneous

In this chapter the results of two wayfinding studies conducted in a subway station and in a virtual replica of that station are presented. Both studies have been carried out by the author and his colleagues. The main goal of the studies was to identify the wayfinding strategies that are used to find an exit in the subway station. For this purpose, the participants were asked to evacuate from the station and answer questions in terms of their route choice decisions.

The participants' route choice distributions at three different choice points within the station are discussed and data gathered from questionnaires and camera recordings is presented. Based on this data the percentage of people who followed signage is inferred. Additionally, further wayfinding strategies that have been applied by the participants are mentioned and discussed.

To investigate the influence of signage on the route choice decisions in the station, the VR-study's participants were divided into two groups. One group was provided with (virtual) signage, the second group was not. The results of these two groups are described and compared to the results of the study in the real subway station. Finally, the limits and possibilities of the VR-study are discussed.

### 8.2 Method

The first study took place in a real subway station in Berlin (real study). The VR-study took place at the University of Wuppertal and at the Research Center Jülich using a head mounted display (HMD).

### 8.2.1 The subway station

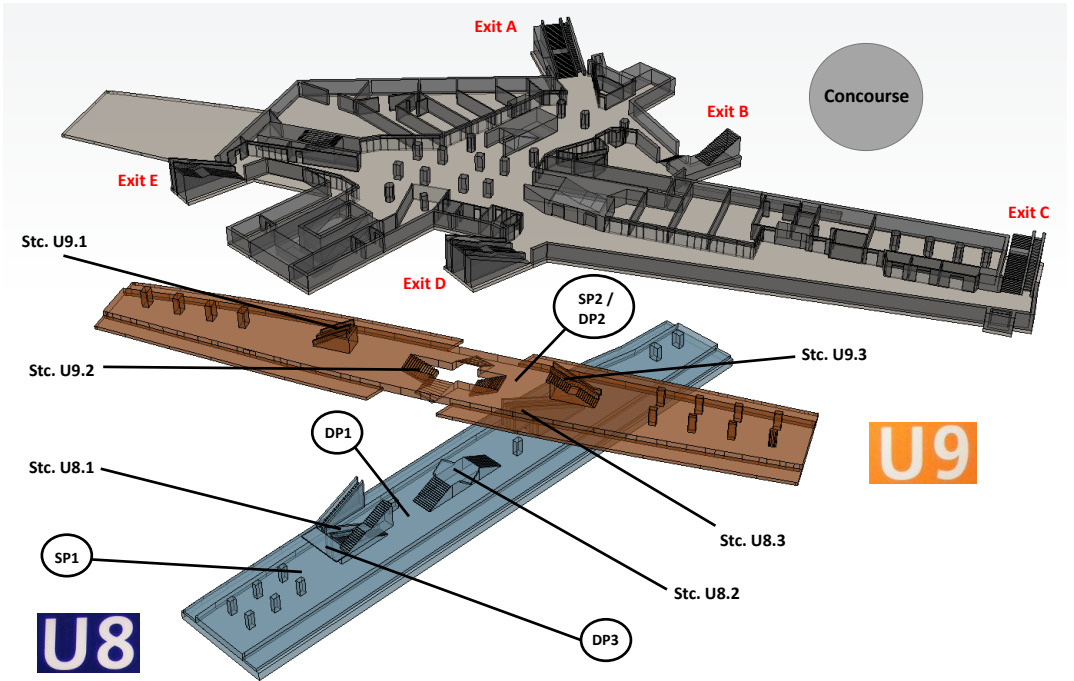

Figure 8.1: Isometric view of the complete subway station in which the here discussed studies took place.

The station consists of three levels. There are two platforms on top of each other and one concourse level above the platforms (see Fig. 8.1). Both platforms U8 and U9 are connected directly to the concourse level by two (in total four) staircases. These are the staircases U8.1, U8.3, U9.1, and U9.3, respectively. A further staircase, Staircase U8.2/U9.2, in the middle of the platforms serves as a direct connection between the platforms. In order to evacuate, it is necessary to go to the concourse level first. The elevators which should not be used in the case of fire are ruled out in the studies' contexts. From the concourse level, the ground level can be reached by using one of the five exits A-E.

The virtual replica of the station has been created by Autodesk's AutoCAD<sup>®</sup>, SketchUP<sup>®</sup> by Trimble Navigation Ltd., and Unreal Engine<sup>®</sup> by Epic Games. A generic model of the station's geometry has been set up with the help of AutoCAD<sup>®</sup>.

Subsequently, photos that have been taken in the real station were used in SketchUp<sup>©</sup> to create textures of walls, floors, ceilings, signs, and objects such as ticket machines. A few further objects e.g. banks, escalators, and railtracks were imported from the SketchUp<sup>©</sup> object repository. Finally, the virtual geometry including textures and objects were transferred to Unreal Engine. Unreal Engine provided the possibility to use the geometry interactively incl. walking through it by using first person perspective.

### Signage in the station



Figure 8.2: a) Yellow-black exit signage present at walls and ceilings in the station. Ausgang is the german word for exit. b) Green-white emergency exit signage installed at the bottom of walls and pillars in the station.

At several locations both the real station and its virtual replica contain three kinds of signs that are relevant for evacuation purposes:

1. Tiny green-white escape route signs (30 cm x 15 cm) (see Fig. 8.2(b)) were installed at walls near the floor so that they are still visible when smoke is propagating at the ceiling.
2. Yellow-black exit signs (Ausgang is the german word for exit) (60 cm x 12 cm) (see Fig. 8.2(a)) are hanging from the ceiling at specific staircases. Smaller versions of these signs are part of a sign that indicates the name of the station and is installed at walls (45 cm x 9 cm).
3. Other, partially electronic, signs are installed at the ceiling indicating the way to a specific platform or giving information about the time of the next train's arrival.

## 8.2.2 Participants

### The real study

32 participants took part in the real study voluntarily. They signed an informed consent agreeing to the record of their data. Data has been recorded anonymously and is used for scientific purposes only. 31 participants fulfilled all five steps of the experiment, one subject only fulfilled the first three steps (see below). 50 % of the subjects were male, ca. 47 % female and ca. 3 % other. 78.125 % stated to be students. The remaining part were employees or self-employed. They were aged in the range from 20 to 31 years (average: 24.8; standard deviation: 2.74). 93.75 % were right-handed, the remaining ones left-handed. Two participants had a temporary physical impairment. Nevertheless, they could move (slowly) on platforms and stairs. 33.33 % stated to have a visual impairment. Except for one of them they stated to be able to see everything clearly (given the case with their vision aid). Except for one who was a german-hungary citizen, all participants were german citizens.

16 of them were first time visitors or had very little knowledge about the station. They stated their knowledge degree to be within the range of 1-2 whereas 8 persons stated their knowledge to be within 3-6 on a scale of 1 to 10. The remaining 8 participants claimed to be familiar with the station (self-rated knowledge degree 7-10).

16 subjects quoted that they used the subway regularly (more than 4 times a week) whereas 9 stated that they used it 1-4 times a week. 5 participants took the subway more seldom than weekly. The remaining part (two) quoted that they never had taken the subway.

### The virtual study

71 volunteers took part in the virtual study. Due to technical issues only measurements of 68 persons could be evaluated. All of them fulfilled every of the experiment's five steps (see below). 43 (ca. 63 %) of the evaluated participants were male, 25 (ca. 37 %) female. Data has been recorded anonymously and is used for scientific purposes without exception. An informed consent has been signed by the participants in advance. 55 (ca. 81 %) subjects were students, 13 (ca. 19 %) stated to be researchers (PhD students, post-doctoral researchers or other researchers). The age of the youngest subject was 18 years, the oldest participant was 57 years old. The mean value of the ages was about ca. 25.5 years. Two persons (ca. 3 %) were indian citizens, one (ca. 1.5 %) was a U.S. citizen, one french and another one was from

Luxembourg. 17 (25 %) participants were chinese citizens, the remaining 46 (67.5 %) persons were german citizens. Two subjects (ca. 3 %) stated to be left-handed, one (ca. 1.5 %) stated to be both-handed. The remaining part of the participants (95.5 %) were right-handed. All participants stated to be capable to see signage clearly (if necessary with a vision aid).

3 participants quoted to use the subway (in general) more than 4 days a week whereas 5 persons use the subway 1-4 times a week and 50 persons not even once in a week. The remaining 10 persons had never used the subway.

62 subjects possessed very sparse knowledge about the spatial set-up of the station. They stated their knowledge degree to within the range of 1-2 on a scale of 1 to 10. 3 participants stated their knowledge degree to be within 3-6. The remaining three subjects were familiar with the station (stated degree within 7-10).

### 8.2.3 Experimental procedure

The experimental procedure contained five steps:

1. First questionnaire in advance
2. First walk
3. Second questionnaire after first walk
4. Second walk
5. Third questionnaire after second walk

#### Real study

In advance, by a questionnaire, participants were asked to provide information about their personal data e.g. age, gender, familiarity with the station, and frequency of general use of the subway (step 1). Subsequently, they were led successively from the gathering point on the concourse level to either Starting point 1 (SP1) on U8 (all participants with an even number) or to Starting point 2 (SP2) on U9 (remaining participants) (see Fig. 8.1). They were led blind folded and by taking detours.

The real study was conducted in the subway's working hours in the evening of a work day. Passenger traffic was still present. Though, congestion on the platform or at the staircases did not occur. At each of the starting points a subject was supposed to assume an emergency situation which causes the necessity to evacuate from the station. A corresponding announcement has been read to them. The participant





Figure 8.3: Real underground station. View from Decision point 1 (DP1) (see Fig. 8.1) towards both stairs U8.1 and U8.2 (left: leading to the concourse level; right: leading to U9).



Figure 8.4: Real underground station. View from Starting point 2 (SP2) on the stair that connects the platforms U8 and U9.

was told not to run but walk normally during his/her evacuation. Subsequently, a participant looked for a way to the outside while a head-mounted action camera was documenting his/her path (step 2). After having reached the outside (ground level), the subject has been led back directly to the gathering point and was asked to fill in a second questionnaire. The second questionnaire contained questions related to their walked path during the evacuation (step 3). In the meantime, the experimenter picked up another participant and led him to a starting point on the platforms. As all participants fulfilled the second questionnaire step 2 and step 3 were repeated. However, participants who already started at SP1 were led to SP2 and vice versa (step 4 and step 5). In the second run (step 4) subjects were asked to comment on their route choice during their walks. The comments were recorded by the microphone of the head mounted camera.



Figure 8.5: Real underground station. Participant is approaching DP3.

### **The virtual study**

After having filled in the first questionnaire, subjects of the virtual study (one by one) were asked to put on an Oculus Rift<sup>®</sup> (DK II) head mounted display. In a virtual training level a participant had to accomplish several locomotive tasks so that he/she could practice to steer around with the head mounted display and a XBOX ONE<sup>®</sup> gamepad. To change their (first person) perspective in the virtual world (looking up,

down, left or right) or even turn completely, a participant could move his/her head or turn physically. To move forward or backward, the gamepad had to be used. At the end of the training level participants were asked to read out an instruction on a sign to make sure that the head mounted display has been adjusted correctly so that signage is clearly visible.



Figure 8.6: Virtual underground station. Coming from SP1 a participant is approaching DP1. Figure does not correspond to the field of view of the subject.



Figure 8.7: Virtual underground station. View from SP2 on Staircase U8.2 that connects platforms U8 and U9. Figure does not correspond to the field of view of the subject.



Figure 8.8: Virtual underground station. Participant is approaching DP3. Figure does not correspond to the field of view of the subject.

Subsequently, step 2 to step 5 of the study were executed. In the virtual station a subject directly began at the starting points on the platforms. In the virtual environment no other (virtual) pedestrians were present.

In step 2 participants with an even ID number evacuated from the virtual station which was provided with signage. The exact same signage that is installed in the real station has been used. Participants with an odd ID number were not provided with signage in step 2.

All subjects started from SP1 in step 2. In step 4, the repetition of step 2, all subjects started from SP2. In this step, participants with an even number faced a station without signage and participants with an odd number were provided with signage.

To simplify the VR-study, the subjects' walking tasks (step 2 and 4) were considered to be accomplished when they reached the concourse level. At this point the simulation of the virtual world has been closed.

### 8.3 Results

In the following section the participants' route choice decisions at the three decision points DP1, DP2, and DP3 (see Fig. 8.1) are discussed. Based on the decisions at these points and the outcomes of the questionnaires strategies are named that

were used by the subjects to find a route to the exit [Hofinger et al., 2016]<sup>1</sup>. As a second step, the influence of signage on the route choice decisions at DP1 and DP2 is investigated. For this purpose, the results of the signage group and the control group of the VR-study are evaluated and compared with each other. Statements in the questionnaires, the videos that have been recorded by the action cameras, and actual route choice decisions are taken into account.

### 8.3.1 Real study

#### 8.3.1.1 Decision point 1

The first decision point (DP1) is located between the two staircases that lead to the concourse level and to Platform U9 (see Fig. 8.9). Here, 25 (ca. 78%) participants chose to use Staircase U8.1 (7 of them by the escalators, 18 by the stairs) whereas the remaining 7 (ca. 22%) persons took Staircase U8.2 [Hofinger et al., 2016]. Nobody decided to stay or proceed on the platform [Hofinger et al., 2016].

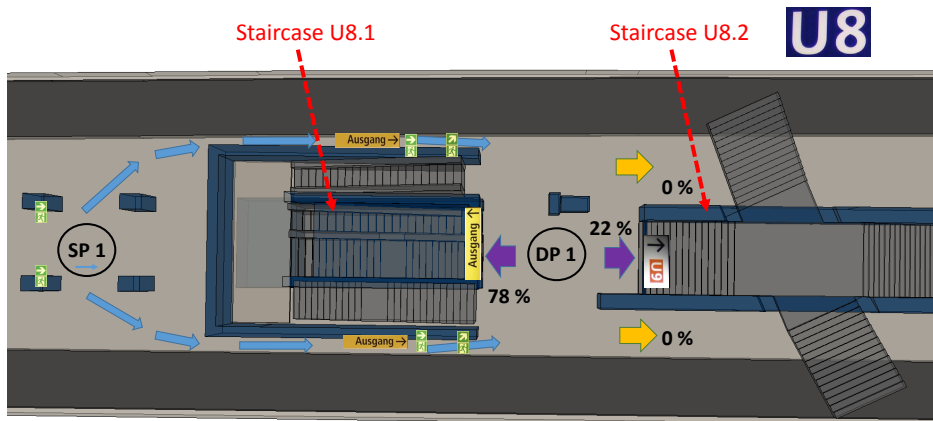

Figure 8.9: Topdown view on parts of Platform U8 around SP1 and DP1. Position of exit signage is marked. Additionally, this figure shows the route choice distribution at DP1 among the participants of the real study.

Based on the data gathered at this choice point the following strategies are mentioned that could have been applied by the participants.

<sup>1</sup>Strategies and their percental usage at DP1 and DP2 in the real station have partially already been shown in Hofinger et al. [2016]

**Use a familiar way (cognitive map or route knowledge)**

Outcomes of Benthorn and Frantzich [1999], and Grosshandler et al. [2005] suggest that people who possess spatial knowledge prefer to take a path they are familiar with despite the existence of exit signage or attractions by environmental factors. On the one hand, this path can be the only known way. On the other hand, the path can be one of multiple known possibilities and may be selected due to the travel time benefit or other comfort benefits. Obviously, this strategy can only be applied by wayfinders with sufficient spatial knowledge. Consequently, in advance, it has been assumed that particularly familiar participants select the path that provides benefits in terms of the travel time. At DP1 this applies for Staircase U8.1 which leads directly to the concourse level. In order to test this hypothesis, the route choices at DP1 of three groups with different spatial knowledge degrees have been compared (see Tab. 8.1). However, only a very slight and not statistically significant increase in the selection of Staircase U8.1 could be found when the knowledge degree increases (Fisher's exact test for count data, p-value = 0.6471).

Table 8.1: Route choice decision at DP1 among three groups of participants with different spatial knowledge degrees (KD).

KD / Route	Stc. U8.1	Other
1-2	12	4
3-6	6	2
7-10	7	1

**Prefer comfortable way**

Participants might have chosen a way that appeared to be more comfortable, not in the sense that the whole path is shorter but that at least a part of the path requires less physical effort. The favoring of the escalators over other stairs is mentioned. Especially people with a physical impairment might prefer escalators. In the real study, 7 participants (ca. 22%) took the escalator [Hofinger et al., 2016]. Contrary to the expectations, the two participants with a temporal physical impairment were not among these persons.

**Follow exit signage**

Another strategy consists of following exit signage (either yellow-black or green-white signs).

Participants behavior and sight as recorded by the head mounted camera suggest that 22 participants based their route choice decision on the presence of yellow-black exit signage at DP1. One subject misinterpreted the green-white exit signage at DP1 and went to Staircase U8.2. The remaining 9 participants ignored signage.

These outcomes suggest that a majority took Staircase U8.1 as it was indicated by signage (see Tab. 8.2). This applies for 22 of the 25 participants who went to Staircase U8.1. In fact, the correlation of the use of signage and the choice for Staircase U8.1 is statistically significant (Fisher’s Exact Test for Count Data, p-value < 0.001).

There is no significant change among the groups of different knowledge degrees in terms of the sign usage (see Tab. 8.3) (Fisher’s Exact Test for Count Data, p-value = 0.5113). The percentage of participants who relied on signage is similar within the three groups of different spatial knowledge degrees. This result is contradictory to the author’s expectation that signage is primarily used by unfamiliar wayfinders.

Table 8.2: Number of participants who used signage in dependency on their route choice at DP1. Data about the sign usage has been collected by observing and interpreting the participants behavior and sight as recorded by the head mounted cameras.

Route / Signs used	Yes	No
Staircase U8.1 (Conc.)	22	3
Staircase U8.2 (U9)	1	6

Table 8.3: Number of participants who used signage at DP1 among three groups with different spatial knowledge degrees. Data about the sign usage has been collected by observing and interpreting the participants behavior and sight as recorded by the head mounted cameras. Information about the knowledge degrees has been collected by the surveys.

KD / Signs used	Yes	No
1-2	12	4
3-6	7	1
7-10	5	3

### Use first visible stair to upper levels

Despite present signs 7 (ca. 22%) persons headed for Staircase U8.2 [Hofinger et al., 2016].

Generally, it is assumed that evacuees in subway stations are attracted by stairs that lead upstairs. This is because they knew that the final exit must be located somewhere above them independently from their position within the station (generalized experience about subway stations). The study’s results comply with this assumption. At DP1 all participants decided to proceed via a stair.

Furthermore, it is assumed that some people head for the first staircase they can see and stick to their decision. They stay with their choice although an alternative appears. Possibly, they do not see any noticeable benefit in changing their mind. This could apply for 3 of the 7 participants that went to Staircase U8.2. These subjects stopped at DP1, looked around, and recognized Staircase U8.1. Nevertheless, they stayed with their decision to proceed to Platform U9. The remaining 4 participants did not look around at DP1. Thus, it is not clear if they perceived Staircase U8.1 at all.

**Select randomly**

It is conceivable that participants didn’t use any of the above listed strategies but chose randomly. However, Fisher’s exact test shows that the participants’ route choice distribution is statistically independent from an uniform distribution (equal probability) which would result from random choices (see Tab. 8.4) (p-value  $\ll 0.001$ ).

Table 8.4: Route choice distribution at DP1 compared to a unique distribution which results by random choices.

Sample / Route	Stc. U8.1	Stc. U8.2	Platf.
Observed	25	7	0
Random	10.67	10.67	10.67

In addition, the number of participants who decided to proceed via Staircase U8.1 is statistically significant (p-value = ca.  $0.036 < 0.05$ ). Even if the 7 subjects who might took the escalator for comfort reasons are not considered, still a statistically significant majority chose Staircase U8.1. This fact suggests that at DP1 the strategies ”Follow exit signage” and ”Use a familiar way” were prevalent.

**8.3.1.2 Decision point 2**

The majority (28 participants or rather 90%) decided to stay on the platform at DP2 (see Fig. 8.10). 20 (ca. 65%) headed for Staircase U9.3, the nearer staircase behind them. 14 of them (45% of all) turned right at the beginning of their travel, 6 left (see



Fig. 8.10) [Hofinger et al., 2016]. The remaining part (26%) passed Staircase U9.2 (7 on their right side, 1 on his/her left side) [Hofinger et al., 2016].

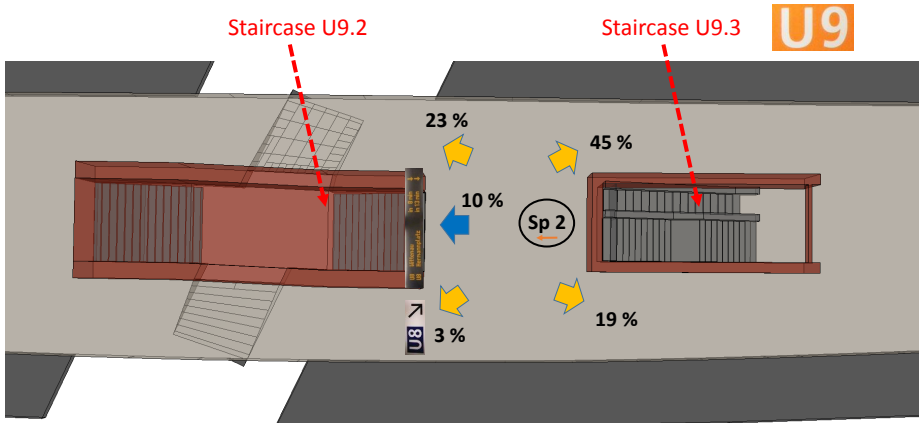

Figure 8.10: Topdown view on parts of Platform U9 around SP2/DP2. Position of exit signage is marked. Additionally, this figure shows the route choice distribution of the real study’s participants at DP2.

Three (10%) used Staircase U9.2 and went downstairs [Hofinger et al., 2016]. The only signage that was visible from this point consisted of two signs. The first one was hanging from the ceiling next to Staircase U9.2 and indicated the way downstairs to Platform U8. The other sign was installed at the ceiling above Staircase U9.2 and showed the time of the next train’s arrival on Platform U8 (see Fig. 8.10).

### Use familiar way

A noticeable part of ca. 71% (20) of the subjects that decided to stay and proceed on the platform turned around and used the staircase behind them. This fact suggests that a majority of them were familiar with this stair and possibly could even identify it as the shortest path to the concourse level. However, the percentage of people who used Staircase U9.3 among familiar participants is not significantly higher compared to unfamiliar participants (Fisher’s Exact Test for Count Data, p-value = 0.7069) (see Tab. 8.5).

Table 8.5: Route choice decision at DP2 among three groups of participants with different spatial knowledge degrees. Information about the knowledge degrees has been collected by the surveys.

KD / Route	Stc. U9.3 (Conc.)	Other
1-2	11	6
3-6	4	4
7-10	5	2

### Use staircase although leading downstairs

At DP2 three persons (10%) used Staircase U9.2 and went downstairs instead of proceeding on the current platform. It is conceivable that they were expecting a directly connected staircase that lead them upstairs again. Indeed, two of them took the opposing stair that leads back to Platform U9 as the only alternatives would take them even further down.

### Select randomly on platform

Although a majority (21 persons or rather 75%) of persons who stayed on Platform U9 turned to the right at DP2, the here present route choice distribution is not significantly different compared to a uniform distribution that results from random choices (Fisher’s Exact Test for Count Data, p-value = 0.075).

#### 8.3.1.3 Decision point 3

At Decision point 3 (podest of Staircase U8.1, see Fig. 8.11) participants were faced with the decision of either to turn right or turn left to proceed to the concourse level. Here, no signage was present.

### Use local shortest way

7 subjects that took the escalator (right side of the staircase) of Staircase U8.1 turned right at the podest. Three turned left and headed for the stair on the other (left) side of the podest. 13 participants of those who took the stairs instead of the escalator turned left whereas 6 further subjects crossed the podest and headed for the stairs on the other side (see Fig. 8.11).

A noticeable but not statistically significant majority (20 persons) stayed on their side (who came on the left side turned left and vice versa) (Fisher’s Exact Test for Count Data, p-value = 0.1821).

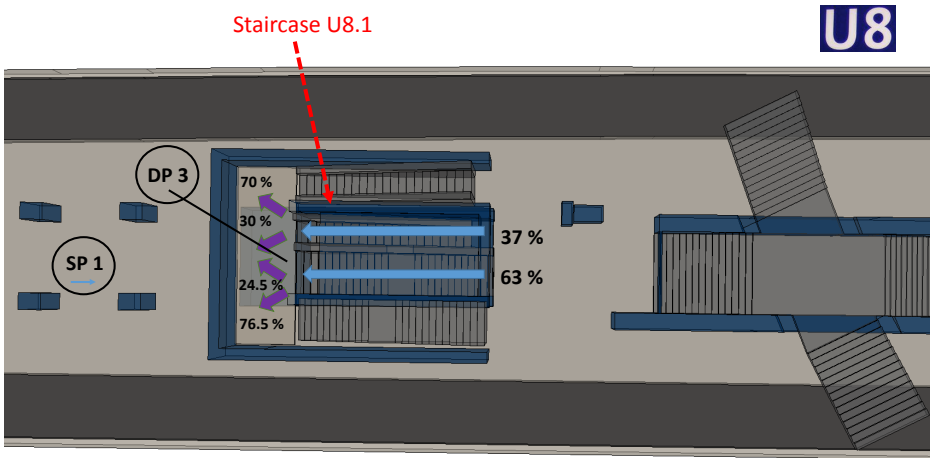

Figure 8.11: Route choice distribution at DP3 in the real study.

### 8.3.2 VR-Study

#### Preliminary remarks

Only 6 participants of the VR-study were at least slightly familiar with the station. This number is too low to obtain representative results in terms of the route choice of people with higher spatial knowledge degrees. Thus, only unfamiliar participants (knowledge degree 1-2) are regarded in the following.

30 unfamiliar participants were among the group that was provided with signage in their first runs. 32 subjects belonged to the control group (no signage). In the participants' first walks through the subway station they started at SP1 on Platform U8 whereas in their second walks they started from SP2 on Platform U9. In the second runs all participants who were not provided with signage in the first place now started in an environment with present signage and vice versa.

#### 8.3.2.1 Decision point 1

##### No-signage group

A major (and statistically significant) part of the participants (87.5%) (see Fig. 8.12) who were not provided with signage favored to use Staircase U8.2. This fact suggests that the use of the strategy "Use first visible stair to upper levels" was prevalent here. The major use of this strategy has been expected as the further strategies "Use

familiar way” and ”Use signage” could not have been applied here. Neither spatial memories nor signage was present.

9.5 % (3) of the subjects took Staircase U8.1. One person chose to use the escalator although the escalator was not running in the VR-study. The remaining two persons took the stair.

One participant proceeded on the platform.

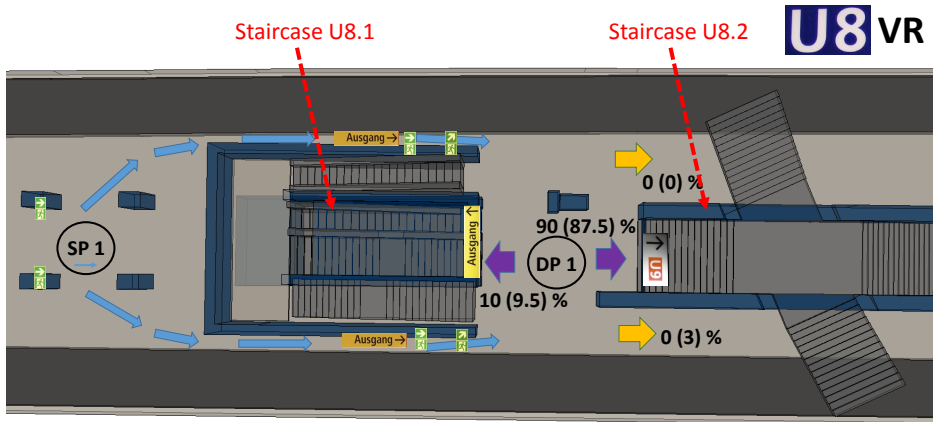

Figure 8.12: Route choice distribution at DP1 in the VR-study of both signage and no-signage (in brackets) group.

### Signage group

In advance, the author expected that the route choice distribution will change remarkably if signage is present. However, despite the presence of signage, still a remarkable (and statistically significant) majority of 90 % (27 persons) headed for Staircase U8.2 (see Fig. 8.12). The remaining 10 % (3 persons) took Staircase U8.1. This outcome is very contradictory to the results of the real field study which showed a noticeable preference for Staircase U8.1 even among unfamiliar participants.

It appears that signage had no influence on the route choice at DP1 as the route distribution of both signage and no signage group is nearly identical (Fisher’s Exact Test for Count Data, p-value = 1). This fact suggests that the strategy ”Use first visible stair to upper levels” was mainly used even though signage was present.

### 8.3.2.2 Decision point 2

Based on the outcomes of the real study, it has been expected that, at DP2, a certain number of subjects use Staircase U9.2 although it leads downstairs. In fact, 5 (16.7%) participants who were not provided with signs decided to proceed downstairs (see Fig. 8.13). Fewer subjects among the signage group (two persons or rather 6.25%) selected Staircase U9.2 as a proceeding way. Though, the difference is not statistically significant. Thus, a significant influence of signage at this point could not be found. 4 of the 7 persons who went downstairs proceeded straight ahead and returned directly to Platform U9 by using the stair on the opposite side. The remaining three persons proceeded to Platform U8.

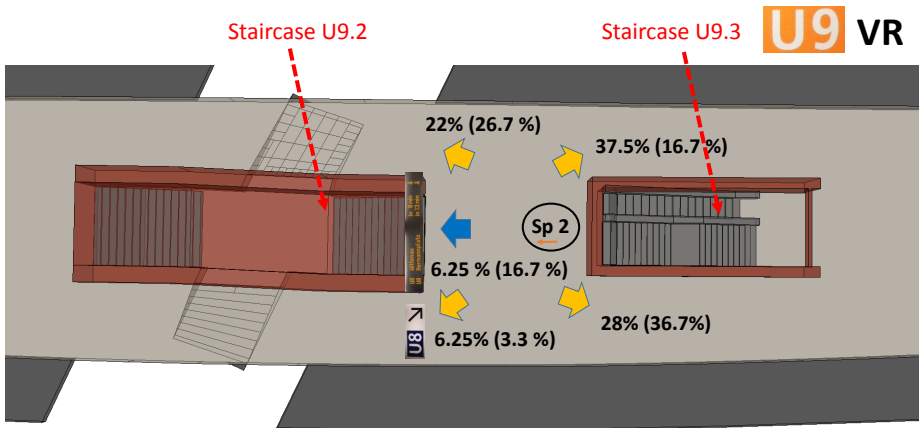

Figure 8.13: Route choice distribution at DP2 in the VR-study of both signage and no-signage (in brackets) group.

The remaining participants stayed on the platform and passed Staircase U9.2 or Staircase U9.3 either by turning left or right. The route distribution of the participants of both signage and no-signage group are similar (Fisher's Exact Test for Count Data,  $p$ -value = 0.869) and not significantly different from a uniform distribution that would result by random choices. This suggests that no features or characteristics were present that caused preferences for a specific way on the platform.

### 8.3.2.3 Decision point 3

As at DP3 no signage was present, the route choice decisions of both signage and no-signage group are pooled. 6 (66.7%) of the participants who went to Staircase

U8.1 decided to take the stair instead of the escalator (see Fig. 8.14). 4 of them turned left (stayed on their side of the staircase) at DP3. The remaining two persons turned right. As seen before in the real study, a (not statistically significant) majority preferred to stay on the side they came from. Two of the three subjects who took the escalator of Staircase U8.1 turned left whereas the remaining one turned right.

Please note that at DP3 the number of participants was too low for profound statements.

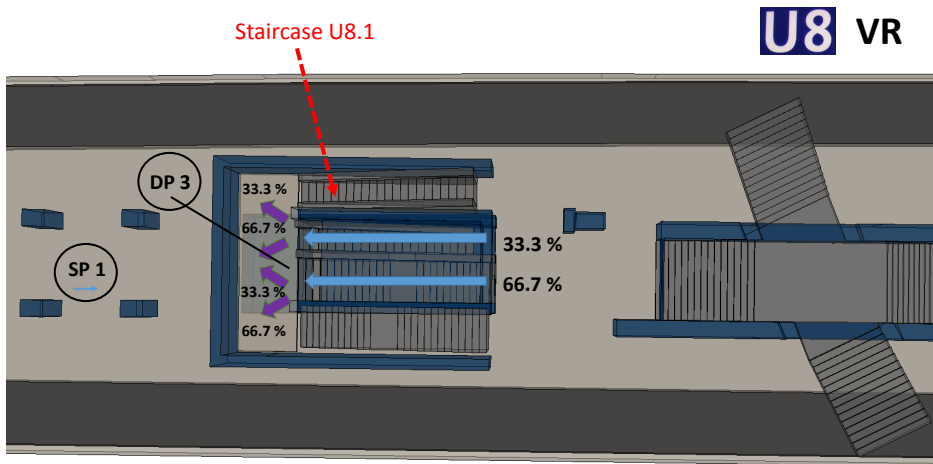

Figure 8.14: Route choice distribution at DP3 in the VR-study.

### 8.3.3 Overall sign perception and usage - Real and VR-study

Subsequent to the walks the participants were asked to fill in questionnaires. In this context, they were asked if they had seen and used signage at some point in the station. Again, differences between real and VR-study can be identified (see Tab. 8.6). The difference of the average use of signage in the real study (81 %) and in the VR-study (51.5 %) is statistically significant. In the first run of the VR-study less than the half of the participants stated that they relied on signage whereas 81 % of participants in the real study followed signs.

Except for 1-2 subjects all participants that saw signage also followed it. In this regard, the results of both studies agree with each other.

Table 8.6: Percentage of participants who saw and used signage in run 1 and 2 of both studies. Values are rounded. Survey data. \*Data from the signage group.

Walk	Real from SP1	Real from SP2	VR* from SP1	VR* from SP2
Signage Seen	84 %	87 %	50 %	60 %
Signage Used	81 %	81 %	43 %	60 %

## 8.4 Discussion - Differences between real and VR-study

The comparison between results from the real and the VR-study turned out that the strategy to follow exit signage was less used among the participants of the VR-study. Particularly at DP1 a majority of the participants of the VR-study ignored them. The comparison of both groups of the VR-study suggests that signage had a negligible influence on the route choices at this point. In contrast, in the real study a noticeable influence of signage has been found.

On the one hand, this difference can be explained by the fact that participants of the VR-study used a corded head mounted display (HMD). The HMD restricted their field of view (ca. 95 degrees horizontal and 105 vertical [Tangient LLC, 2017]). The field that can naturally be seen by the eyes comprises 135 degrees vertical and 200 degrees horizontal [Dagnelie, 2011]. Additionally, as the HMD was corded, participants partially avoided to turn about more than 90 degrees although they were supported by an experimenter. Due to the restrictions related to the HMD participants might have missed signage that only could have been seen by remarkable turning. Particularly, this applies for signage at DP1. Independently from the capability or willingness to turn the difference in terms of sign usage suggests that real signage is generally more salient. This agrees with the fact that participants' field of view and the resolution of objects were restricted in the VR-study due to the HMD.

On the other hand, in the real study other people (passengers) were present during the study. Even though participants did not follow other people, the passengers might have set the participants' focuses to specific ways or rather made them be aware of certain signs. These signs might have remained uncovered in an empty subway station.

A significant influence of spatial knowledge on the route choices could not be found in the real study. However, familiar participants possibly knew that signage is present in the station and were familiar with its layout. Thus, these participants might have been more likely to rerecognize the signs whose layout they already had seen before. By contrast, the vast majority of subjects in the VR-study has never

been in the station and did not know anything about the signage or its properties such as layout, size or color.

## 8.5 Summary and Conclusions

Results of wayfinding studies carried out in a real subway station and in a virtual replica have been presented. Wayfinding strategies have been identified that were used by the participants at three choice points in the station. Results of both studies showed that a significant majority of subjects were attracted by staircases that lead upstairs. This outcome emphasizes the significance of generalized knowledge.

At DP1 a significant number of people of the real study selected the staircase which was indicated by signage. In consequence, at this point the prevalent strategy has been to follow signage in combination with the selection of a staircase. Further strategies that have been used by few subjects of the real study are to choose a familiar way (applies only for participants with sufficient spatial knowledge), take the first visible stair that leads upstairs or the selection of a more comfortable way (in this case the selection of the escalators).

It has been expected that especially familiar subjects preferred to take a known way and thus did not follow signage to find an exit. However, the percentage among familiar people who relied on signage turned out to be similar to the percentage among unfamiliar subjects. Furthermore, a statistically significant change in terms of the route choice when comparing participants with different knowledge degrees could not be found.

Apart from a few exceptions, all participants who saw signage also used it to evacuate from the station. This agrees with the results of the studies by Xie et al. [2012] and Galea et al. [2014].

In the VR-study a significant majority among the signage group decided to take Staircase U8.2 at DP1. The percentage of participants who selected this stair is almost identical to the number of persons among the control group. This suggests that signage had a negligible influence at this point. Hence, the author concludes that signage in the VR-study was not salient enough to be perceived by persons who did not search for signage actively. The lack of salience could be caused by technical restrictions of the VR environment.

In contrast to the differences in terms of the use of signage both studies showed a high influence of stairs which lead upstairs on the route choice decisions. Among all participants from the two studies only one persons stayed on the platform at DP1



whereas all others decided to take a staircase. This result agrees with the outcomes of the study by Shiwakoti et al. [2017] where subjects preferred to take staircases as well.

In both real and VR-study (signage and control group) a significant majority of participants stayed on the platform at DP2 instead of using the stair that leads downstairs. There was no statistically significant preference for one of the four proceeding ways on the platform. Among the small number of people who went downstairs more than a half decided to proceed back upstairs to the original platform subsequently.

At DP3 it has turned out that participants tended to stay on the side of the staircase they came from instead of crossing the pedestal. Though, the number of persons who showed this behavior was not statistically significant.

## 8.6 Model calibration

### 8.6.1 Generalized knowledge

One of the major outcomes of all the above described studies is that all participants except for one in the VR-study favored to use an upleading staircase over staying on the platform. In Sec. 4.2 the assumption has been introduced that stairs are preferred in comparison to any type of room on the same floor. This assumption is confirmed for upleading staircases in subway stations. Therefore, agents in simulated subway stations favor upleading stairs over proceeding on the same level.

### 8.6.2 Sign usage

For the following model calibration the field studies' results are utilized. It is assumed that these results more reliably describe wayfinding behaviour in real world scenarios in comparison to the VR-study.

As mentioned, in the second run of the real study subjects were asked to comment on their route choices during their walks. These comments have been recorded by a head-mounted action camera.

In this run 24 of 32 participants (75%) stated that they saw and used the first sign they reached (see Tab. 8.7). 11 of them started from SP1 whereas 11 subjects started from SP2. Except for one subject, all of them maintained the strategy to use signage in the further course of their paths. The further course comprises one or two decision points on the concourse level depending on the chosen path. All participants who used the second sign on their way also used the third one if applicable.

Three subjects failed to perceive signage at first but detected the second and all subsequent signs they approached. Two participants based their first decision on signage but ignored the second sign of their paths. The remaining 5 did not rely on signage at all.

It is assumed that the comments of up to two participants have been interpreted incorrectly as, in a few cases, the participants comments and behaviour was open for more than one interpretation or rather did not have an obvious meaning. Consequently, in Tab. 8.7 the number of sign users are given under consideration of an error range of up to two persons.

Table 8.7: Number of participants who saw and used the first and the second sign they approached. Data collected from comments which the subjects made during their walks.

First sign / Second sign	Used	Ignored
Used	$22 \pm 2$	$2 \pm 2$
Ignored	$3 \pm 2$	$5 \pm 2$

For the calibration, the error range is not considered. The modeling approach representing the detection of signage comprises four parameters that need to be calibrated. First of all there is the probability  $P$  that the initially approached sign is perceived (see Eq. 5.1). 24 of 32 subjects (75%) perceived the first sign and followed its instruction. In consequence,  $P$  is set to 0.75. Furthermore, the model comprises the parameters  $\zeta$  and  $\eta$  which describe the increase and decrease of the likelihood to detect signs depending on whether previous signs were perceived or not. 22 of them (ca. 91%) maintained their strategy and followed the second sign as well. The likelihood to perceive signage has increased by 0.16. Hence,  $\zeta$  is set to 0.16. Consequently, the probability to perceive the third sign for agents who detected the first two signs is 1 (see Eq. 8.1). This agrees with the study's results. Among the 8 subjects who failed to perceive the first sign three persons (37.5%) used the second. As expected the percentage of persons among the group of subjects who ignored the first sign decreased. Based on this outcome  $\eta$  is set to 0.375. Thus, the likelihood to perceive further signs for persons who ignored both the first and the second sign is 0 which agrees with the results of the study.

The summation of the calibrated model parameters yields to

$$P_0 = P = 0.75; \quad P_i = \begin{cases} 0.75 + m \cdot 0.16 & \text{if a previous sign detected} \\ 0.75 - n \cdot 0.375 & \text{if no sign detected yet} \end{cases} \quad (8.1)$$

with  $m \in \mathbb{N}_0; \quad n \in \mathbb{N}_0; \quad i \in \mathbb{N}.$

### 8.6.3 Reproducing the field study's route choice distribution at DP1

Under consideration of the above shown calibration the interaction of models for signage perception and application of generalized knowledge predicts the following route choice distribution at DP1. 75% of the agents take Staircase U8.1 as these agents perceive the sign above the staircase and follow the instruction. The remaining 25% take Staircase U8.2 as they fail to perceive signage but use the first staircase they can see. No agent proceeds on the platform.

Table 8.8: Comparison between observed and predicted route choice distribution at DP1.

Route choice	Field study	Simulation	Deviation
Stc. U8.1	78 %	75 %	3 %
Stc. U8.2	22 %	25 %	3 %
Platform	0 %	0 %	0 %

Tab. 8.8 shows that the interconnected models can reproduce the route choice distribution at DP1 with a good precision. The deviation between observed and predicted distribution is about 3% which corresponds to one participant.

### 8.6.4 Discussion

The good agreement between predicted and observed distribution at DP1 has been expected due to the fact that the calibration is partially based on observations made exactly at this point. Thus, it only has been shown that the model framework is technically able to reproduce observed route choice decisions. This procedure is by far not tantamount to a validation. Thus, the applicability of the calibrated model in other environments or even in other subway stations is not guaranteed. In fact, a study by Xie et al. [2007] showed that the proportion of sign users can be very much lower (39%). Here, the model with the here calibrated parameters would fail to reproduce the observed route choice distribution.

**Part IV**  
**Case Study**



# Chapter 9

## Application to an evacuation of a subway station

### 9.1 Miscellaneous

In this chapter the previously introduced modeling approaches for wayfinding tools and strategies are applied and discussed in the context of a series of simulation runs. The runs have been carried out in a virtual (JuPedSim-conform) model of the subway station that already has been introduced in Chapter 8.

The subway station is regarded as a complex building as it consists of three levels, two platforms, and a concourse level. For this reason, finding a path to the ground level or to the outside is not trivial. Route choices and the selection of wayfinding tools and strategies can influence the overall evacuation progress. With the help of the case study the effects of single wayfinding strategies and combinations of strategies on the occurrence of congestion and on the final egress time are demonstrated. Particularly, it is discussed how effectively present signage supports the evacuation progress.

### 9.2 The station (simulation geometry)

As mentioned above, the station consists of three levels that are arranged vertically (on top of each other). The ground level can be reached from the concourse level, the topmost level. Five exits (A-E) are available here (see Fig. 9.1). It is possible to go directly from Platform U8 to the concourse level by using one of the staircases U8.1 and U8.3. Staircases U8.2/U9.2 connect both platforms with each other. The remaining stairs U9.1 and U9.3 provide a connection between Platform U9 and the concourse level (see Fig. 9.1). The dimensions of platforms U8 and U9 are approximately 110 m x 12 m and 117 m x 13 m, respectively. The dimensions of the concourse

level are 117 m x 60 m. The mentioned values refer to the longest distance of the long axis and the longest distance of the transverse axis.

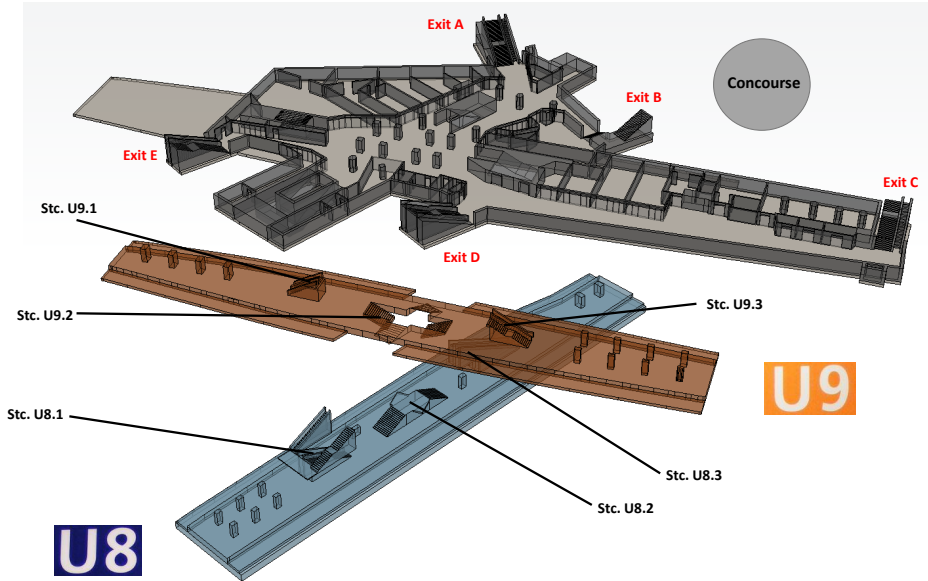

Figure 9.1: Isometric view of the subway station that is the subject of this case study.

To simplify the case study, the obstacles on the platforms (pillars and ticket machines) and the sales areas on the concourse level have been removed. Certainly, (the persons in) the sales areas and obstacles affect the evacuation progress. However, the purpose of the case study is not to predict real egress times but rather to evaluate the influence of wayfinding strategies. Route choices are not changed by the mentioned simplification of the geometry. Thus, the comparison is still feasible with the simplified version. In addition to sales areas and obstacles, the final stairs at the exits A-E are excluded. Consequently, an agent's evacuation is considered to be completed when it reaches the foot of a final stair. Only pedestrians on the platforms, stairs, and on the concourse level are taken into account. Trains and their passengers are not considered. The geometry that has been used for the simulation is shown in Appendix B.

### Signage in the station

The properties of the yellow-black and green-white exit signage in the station already have been described in Chapter 8. These are not relevant for the simulation as they are not explicitly considered by the modeling approaches. In contrast, the model takes into account the parameters  $P$ ,  $\eta$  and  $\zeta$  that are given by the user and comprise the effects of the signs' properties. However, the signs' locations, their heading directions and the directions of their instructions certainly are relevant. Figs. 9.2 and 9.3 show the locations and directions of all signs implemented for the simulation. For the reason of simplification, only the yellow-black exit signage is used.

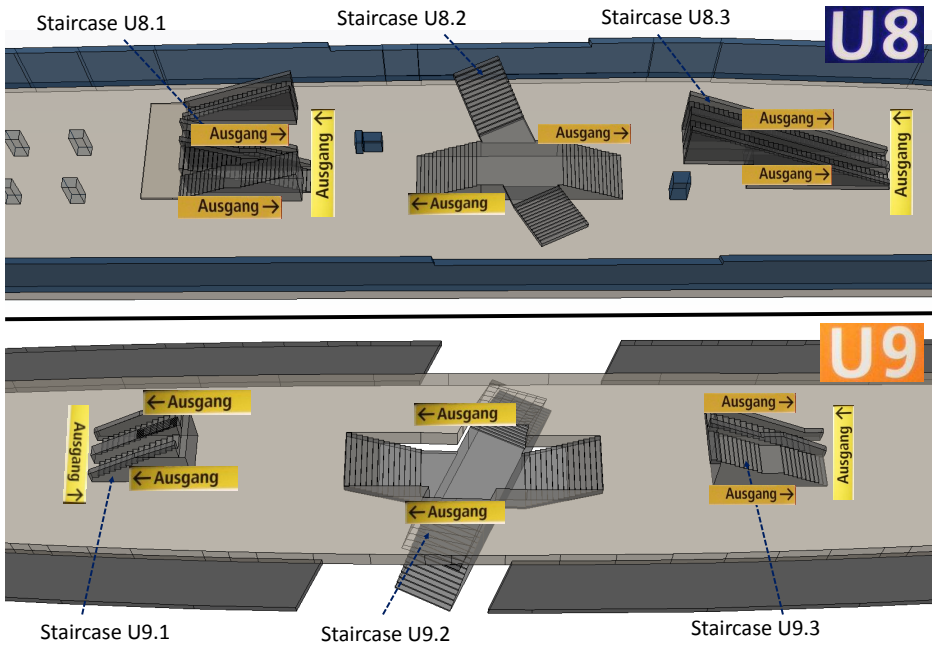

Figure 9.2: The positions of yellow-black exit signs on platforms U8 and U9.



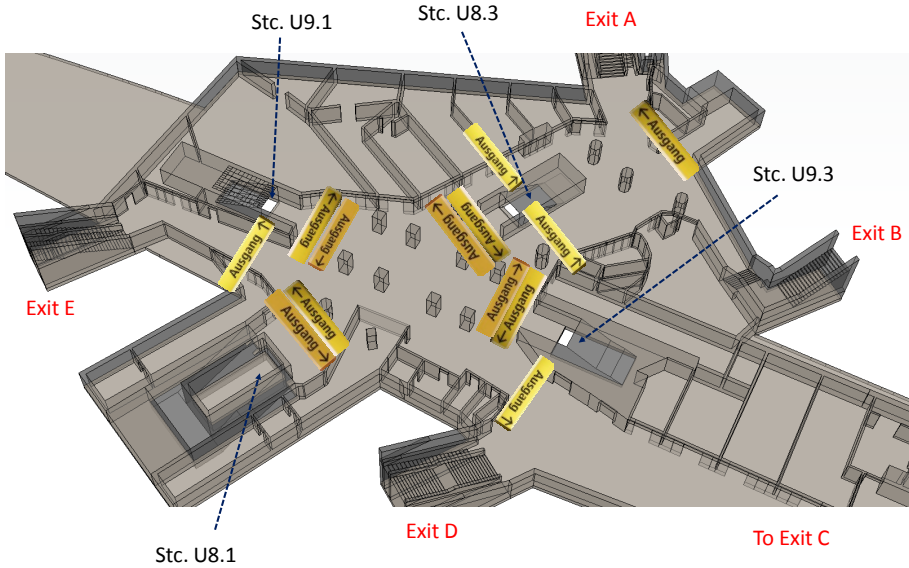

Figure 9.3: The positions of yellow-black exit signs on the concourse level.

## 9.3 Initial conditions

For a study by Hofinger et al. [2016] occupants on the platforms and on the concourse level of the regarded station have been counted in the evening hours of a workday. The counts have been started shortly before the maximum occupant number has been expected on the platforms. Approximately 240 passengers on Platform U8, 160 passengers on Platform U9, and further 170 persons on the concourse level were counted. These numbers can be considered as the peaks of occupancy on each of the levels. These numbers are used in the present case study. Additionally, it is assumed that a few further persons are located on the several staircases of the station (in total 80 passengers). In consequence, the total number of agents in the simulation runs is about 650. The start positions of these agents are randomly determined within the levels and staircases.

JuPedSim's implementation of the model by Tordeux et al. [2016] takes care about the operational tasks of the agents. The agents' average desired speed is about 1.34 m/s in the plane and 0.6 m/s on the stairs and escalators. More infor-

mation about used parameters of the operational model are given in Appendix C. Pre-movement times are not considered.

## 9.4 Route choice models

50 simulation runs have been carried out with the above mentioned geometry, occupancies, initial conditions, and with one of the following route choice models.

### Model A "Stc.": Use upleading stairs

The agents are capable of perceiving stairs. They prefer staircases which lead them upstairs closer to the ground level (basic generalized knowledge of subway stations). If there are no stairs in sight, the agents choose a proceeding way randomly. Though, once decided for a way, they maintain their choice unless they have to turn around or a stair appears (see Sec. 3.5). All agents ignore signage and possess no spatial memories.

### Model B "Signs": 100 % of agents use signage

Here, the agents retain the capabilities they were provided with in Model A. Additionally, now, 100 % of the agents use signage. Once having perceived a sign, an agent relies on further signs as well. They follow all signs they can see physically during their evacuation. Accordingly,  $P$  is set to 1.0.  $\eta$  and  $\zeta$  are set to 0.

### Model C "Fam.": Familiar agents

In this scenario the agents are provided with some spatial memories about the station's structure. Particularly, they know which of the staircases take them directly (without detours) to the concourse level and therefore faster to an exit. For this purpose, all agents starting from one of the platforms obtain a cognitive map that contains the positions of staircases that lead to the concourse level. Due to their cognitive maps the agents immediately head to the closest of the mentioned stairs. Once reached the concourse level, they decide a proceeding path randomly.

### Model D "Col.": Collaboration (Interaction) of strategies

In this scenario 50 % of the agents are considered to be familiar and thus head to the closest available stair to the concourse level if they start from one of the platforms. The remaining agents are unfamiliar.

Additionally, signage is present in the station and is perceived by a certain part of agents. The parameters from the model calibration described in Sec. 8.6 are considered. These are  $P = 0.75$ ,  $\eta = 0.16$ , and  $\zeta = 0.375$ , respectively.

### Model E "SP": Shortest Path

Here, agents use their predetermined shortest path without exception. This scenario serves as a reference for comparison to the previously mentioned scenarios. The paths are calculated by the shortest path algorithm that is implemented in JuPedSim.

### Model F "TTO": Travel time optimization

The agents still use their shortest path in principle. However, now, they try to find an alternative route to optimize their travel time if they are faced with a congestion. For this purpose, the travel time optimization model by Kemloh Wagoum, Armel Ulrich [2013] that is implemented in JuPedSim has been used. This optimization model enables agents to find and use an alternative route that provides a remarkable benefit in terms of the travel time. If there is no route that comes along with a noticeable benefit, the agents stick with their shortest path.

## 9.5 Results

Due to numerical instabilities and implementation deficiencies situations occur in which a small part of the agents get stuck at certain points in the station and thus do not continue their evacuation. This applies for applications of all used route choice models. These agents are left out of the evaluation. Hence, the following results refer to the evacuation progress until 585 agents (90%) have evacuated.

### 9.5.1 Overall egress times

Fig. 9.4 shows the distributions of egress times in the station that result from the usage of the above mentioned route choice models.

In agreement with the author's expectation agents evacuate most rapidly if each of them either uses signage correctly or is routed by the travel time optimization algorithm. This is mainly caused by the fact that both models "Signs" and "TTO" make agents avoid detours, particularly the detour from Platform U8 via Platform U9.

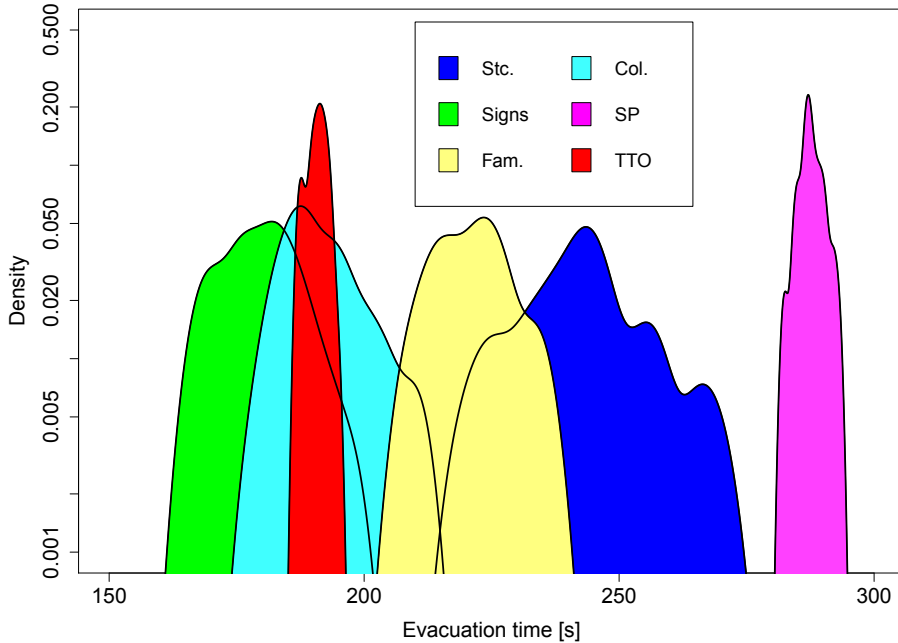

Figure 9.4: Distributions of egress times in the subway station under consideration of various route choice models.

In contrast, the application of the shortest path algorithm (without any travel time optimization) is accompanied by the highest egress time compared to all other used models. This is due to the fact that for a remarkable number of agents the shortest route leads via Staircase U8.1. All agents on Platform U8 move to this stair in the first place except for those who start very closely to Staircase U8.3. This causes a congestion in front of the staircase and also on its podium. In addition, the majority of agents which evacuate via Staircase U8.1 takes the narrow escalator instead of the wider adjacent stair because the escalator is part of their shortest path. This is a further remarkable factor that increases the jam in front of Staircase U8.1 and the overall egress time which is about 287 seconds in average.

In contrast, the travel time optimization makes agents avoid the narrow escalator and re-route via the adjacent staircase. This improves the evacuation progress and decreases the overall egress time. The use of this model results in an average evac-

uation time of 190 seconds (see Fig. 9.4). Nevertheless, still more than 75% of the agents on Platform U8 want to evacuate via Staircase U8.1. They consider re-routing only after having reached the congestion in front of the staircase. Then, the paths via other staircases are too long to provide a worthwhile benefit in terms of the travel time and agents rather continue waiting in the jam.

In the presence of signage the agents are more evenly distributed over the staircases on Platform U8. Therefore, the average egress time for the model "Signs" (about 179 seconds) is even lower than using the travel time optimization (see Fig. 9.4).

The spatial knowledge that is provided to the agents when applying model "Fam." ensures that the agents on Platform U8 avoid the detour via Platform U9. Furthermore, they take the staircases that are connected to the concourse level almost evenly. Though, on the concourse level they need more time to find a final exit in comparison to scenarios in which they are directly guided to an exit (either by signs or by predetermined paths). In consequence, the overall egress time which is about 221 seconds in average is higher in comparison to the scenarios that apply the model "Signs" or "TTO".

When model "Stc." is used, agents take the first visible staircase they see. This causes a noticeable part of the agents to make detours. Particularly, the detour from Platform U8 via Platform U9 increases the overall egress time. In addition, the agents spent more time on the concourse level to find the outside as they are not guided to an exit. Here, the average overall egress time is about 242 seconds.

Model "Col." leads to egress times that, in average, are located between the resulting times of the scenario with familiar participants and the scenario in which everybody follows signage. The corresponding average egress time is about 191 seconds. In this scenario, there are a few agents that neither are provided with spatial knowledge nor perceive and follow signage. Consequently, in comparison to agents which follow the signs these agents need more time to arrive at the concourse level (partially they proceed via Platform U9) and to find an exit on the concourse level. These agents delay the overall evacuation.

### Variation between route choice models

The difference between the smallest (167 s) and the largest egress time (293 s) is about 126 seconds. The egress time can differ by 68 seconds from the mean. This equals approximately 30% of the average egress time (ca. 225 s) of all scenarios.

The comparison between the scenario "Signs" in which signage is present and detected by all and the scenario with no signage ("Stc.") suggests that signage can

significantly improve the evacuation progress. The according route distributions are statistically independent as the confidence intervals do not overlap ("Stc.": [177,181], "Signs": [238,246]). In average, the evacuation process in the station can be shortened by signage by approximately one minute. This equals ca. 25 % of the average egress time of model "Stc.". It has to be noted that the improvement by signage of one minute only can be achieved if all passengers would detect and follow signage.

### 9.5.2 Investigation of selected flows at staircases and exits

In this subsection the evacuation progresses under the usage of model "Stc.", "Signs", and "TTO" are investigated in more detail. For this purpose, the time courses of flows at stairs and exits are presented for the scenarios that uses the mentioned route choice models. In the following diagrams the flow equals the average flow of the respective time interval of 5 seconds.

For each of the route choice models 50 simulations have been executed. In each run the agents' starting positions have been set randomly and thus are different compared to other runs. In consequence, also the flows can be different at each of the 5-seconds time intervals. In order to consider this variety, both the maximum and the minimum flow of a time interval is presented in the diagrams. The course of the minimum flow is drawn dashed whereas the maximum flow is shown by a solid line.

#### Flow at the feet of the staircases on Platform U8

Application of the travel time optimizer let many agents evacuate via Staircase U8.1 which lies on their shortest path. This applies even for agents which start on Staircase U8.2. This leads to congestion at the foot of the staircase and thus to a flow near the capacity that stays high for a relatively long time. The capacity of the staircase<sup>1</sup> (stair + escalator) which is about ca. 2.25 1/s is reached in the first minute of the simulation (see Fig. 9.5(a)). In consequence, congestion occurs. The flow in the scenario in which signage is present decreases earlier. In this scenario a majority of the agents that starts from the lower side of Platform U8 are guided to Staircase U8.3. Hence, the agglomeration in front of Staircase U8.1 consists of less agents and dissolves earlier.

If no signage is present, agents use Staircase U8.2 more frequently which relieves Staircase U8.1 additionally (see Fig. 9.5(b)).

<sup>1</sup>Calculated using the specific capacity for upleading stairs of 0.81/(ms) [Forschungsgesellschaft für Straßen- und Verkehrswesen, 2009]

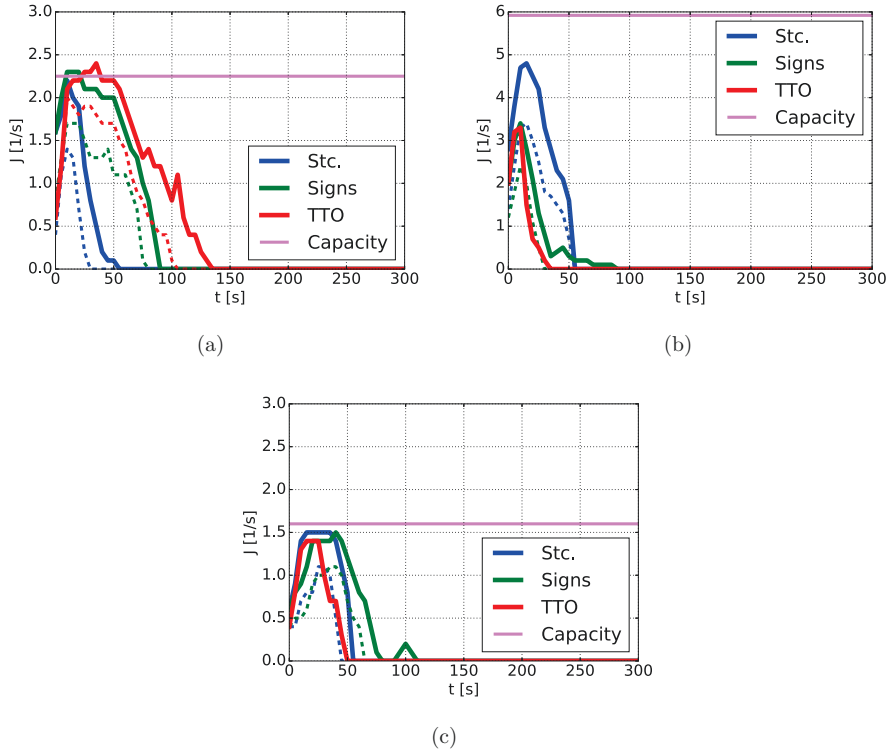

Figure 9.5: Course of the flow at the feet of the four staircases on Platform U8. a) Staircase U8.1 b) Staircase U8.2; The flows at the two stairs that belong to Staircase U8.2 are summed. c) Staircase U8.3

In the scenario in which signage is present, Staircase U8.2 is mainly used by agents that start between this stair and Staircase U8.3. Here, no signage is visible that would make agents refuse it. Congestion does not occur in front of Staircase U8.2 in any scenario.

Relatively few agents that are routed by the travel time optimizer take Staircase U8.3. Only agents which start from a position very close to Staircase U8.3 do not head to Staircase U8.1. Consequently, the flow decreases earlier at this point in comparison to the other scenarios. In every scenario the capacity of the stair which is about  $1.61/s$  is nearly reached in the first 50 seconds.

### Flow at the feet of the staircases on Platform U9

Figs. 9.6(a) and 9.6(b) show that more agents evacuate via Staircase U9.1 and U9.3 when Model "Stc." is used. In this scenario, more agents come from Platform U8 since they were not guided directly to the concourse level by signage or a travel time optimizer. Consequently, the flows at both staircases stay above 1.0 1/s in the first two and a half minutes. Therefore, the evacuation of Platform U9 takes approximately one minute longer in comparison to the scenario with present signage.

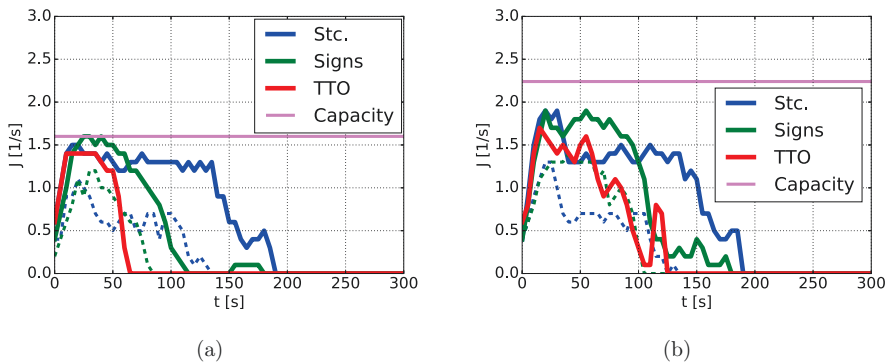

Figure 9.6: Course of the flow at the feet of the two staircases on Platform U9. a) Staircase U9.1 b) Staircase U9.3

The flow in the other scenarios drops off earlier. This applies especially for the scenario that uses the Model "TTO". Here, even agents that start from the podest of Staircase U8.2 prefer to avoid Platform U9 and go downstairs to Platform U8. Thus, still less agents approach the staircases on Platform U9 and the flow at Staircase U9.1 already drops off after 60 seconds.

In the first 100 seconds the flows at the stairs of Platform U9 are temporarily higher in the scenario with present signage in comparison to the scenario without signs. Here, the agents are directly guided to the stairs. They don't have to explore the platform and thus are able to avoid detours. In consequence, a higher number of agents arrive sooner at the stairs. The capacity of Staircase U9.1 (1.61/s) is therefore temporarily reached which comes along with a congestion of short time (approximately 25 seconds).

The capacity of Staircase U9.3 (2.25 1/s) is not reached in any scenario at any time.



### Flow at the exits on the concourse level

Figs. 9.7 a) - e) show the flow courses at each of the exits on the concourse level. Particularly in terms of exits A, D, and E, the respective figures show that the agents need more time to evacuate if they do not use signs or are guided by the travel time optimizer. On the one hand, this is due to the fact, that a remarkable part of these agents spent more time on the platforms and therefore arrive ca. one minute later on the concourse level (see above). On the other hand, some agents need more time to find an exit on the concourse level without guidance. Consequently, the flow exceeds the other flows in the later course of the evacuation progress (approximately in the time interval 150 - 250 seconds).

Exit D is heavily frequented by agents that are routed by the models "Stc." and "Signs". This exit is mainly used by agents which come to the concourse level via staircases U8.1 and U9.3. Exit D is visible from an area close to Staircase U9.3. Most agents that use this staircase pass this area and see Exit D subsequently. They head to the visible exit as the route choice model dictates that they prefer upleading stairs and exits although signage indicates exits in different directions. Nevertheless, the capacity of Exit D (3.6 1/s) is not reached in any scenario.

Many agents that are guided by the travel time optimizer evacuate via Exit E. This applies especially for agents which start on Platform U8 and whose shortest path leads via this exit. The last agent crosses the exit line of Exit E not before 190 seconds after the start. This is about approximately 35 seconds later in comparison to the last agent at any other exit. At first sight, this might be surprising since there is no congestion in front of Exit E. However, 150 seconds after the evacuation's start agents still are approaching Exit E because they were part of the congestion at the foot of Staircase U8.1.

In the other scenarios the last agents leave the building simultaneously at multiple exits. There is no exit which is still used while agents at other exits already evacuated. This suggests that the agents in the scenarios using model "Stc." and "Signs" are more evenly distributed onto different routes and onto different exits.

Exit C is only used by agents that were located closely to this exit at the beginning of the evacuation. All other agents which head to the direction of this exit pass Exit D necessarily. Consequently, they evacuate via Exit D.

In each of the scenarios Exit B is also mainly used by agents that start in the nearer surroundings. In scenario "TTO" this applies also for Exit A. Both exits are relatively far away from the other parts of the concourse level and from the staircases. Hence, these exits are refused by the majority of agents that are routed by the travel

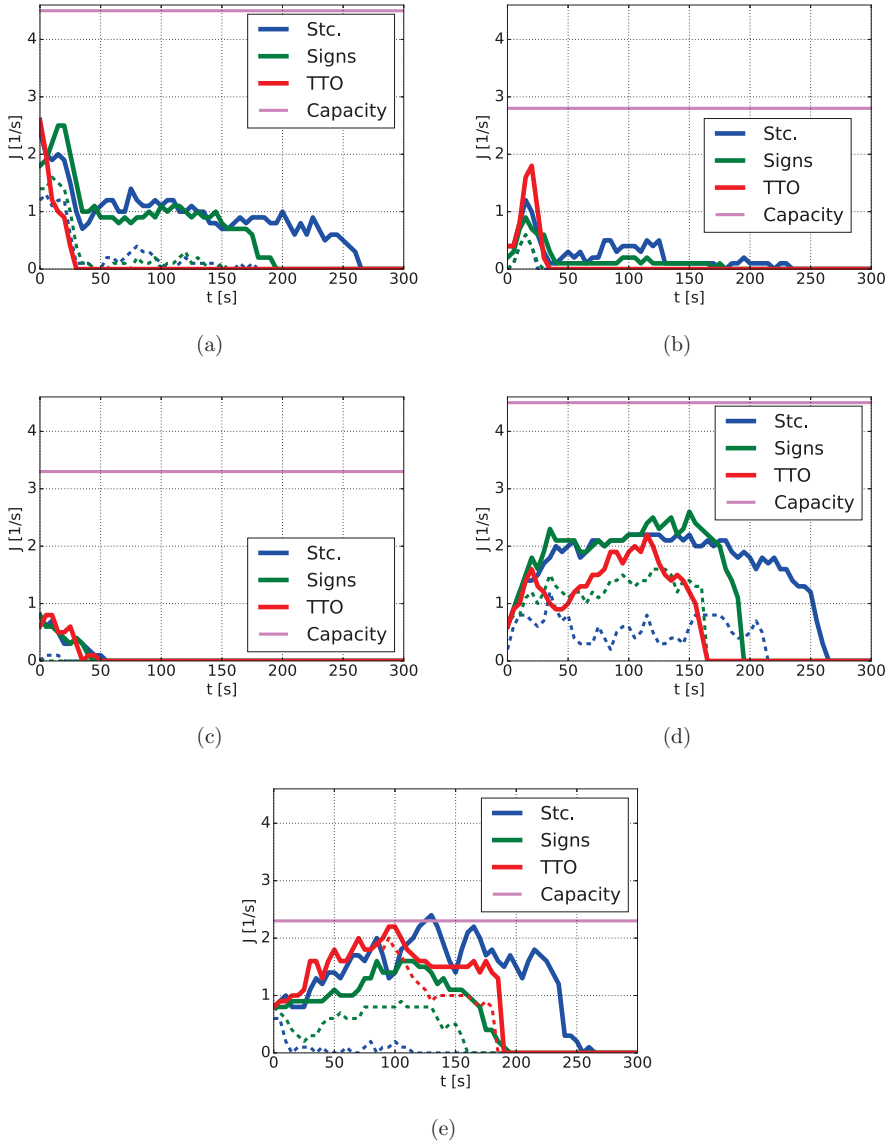

Figure 9.7: Course of the flow at the exits on the concourse level. a) Exit A b) Exit B c) Exit C d) Exit D e) Exit E

time optimizer. The situation is different in the other scenarios. Here, agents come to the area in front of Exit A and B from other parts of the concourse level or from the

platforms. These agents prefer to use Exit A. This is caused by the fact that signage is present that indicates Exit A. Besides, when an agent approaches this area, he firstly sees Exit A and therefore heads to it.

## 9.6 Summary and discussion

Modeling approaches introduced in this paper were applied in the context of a set of evacuation simulations in a subway station. They were used to investigate the influence of different wayfinding strategies on the evacuation process in the station. Six different route choice models have been applied that represent the strategies "Use signage", "Take the first visible stair", "Use spatial knowledge", and interaction of these. In addition, a shortest path and a travel time optimization algorithm have been utilized. Overall egress times and flow courses that result from the application of these six models have been presented and discussed.

It turned out that the average egress time decreases by ca. 25% if the agents follow signage instead of taking the first visible stair which improves the evacuation process remarkably. Mainly, this improvement refers to the fact that agents do not make a detour via Platform U9 if they are guided by signage.

The average egress time is even lower than the average egress time resulting from the scenario in which the agents are routed by a travel time optimizer. In both scenarios agents that start on Platform U8 are directly routed to the concourse level and thus avoid a detour via Platform U9. However, many agents on Platform U8 are guided via Staircase U8.1 as it is part of their shortest path. In front of the staircase they approach a congestion. As from this point alternative routes that avoid the congestion are too long and thus do not provide any noticeable benefit, the agents decide to stay in the congestion. In contrast, agents are more evenly distributed over the staircases when they are guided by signage. In this case, the congestion in front of Staircase U8.1 vanishes earlier which shortens the average overall egress time.

The analysis demonstrated that the modeling approaches introduced in this work are suitable tools to evaluate the influences of various wayfinding tools on the evacuation process. The model framework might not be elaborated enough to predict the single egress time that can be taken for real. This is i.a. caused by the fact that still wayfinding tools e.g. herding are not considered although they may have a strong influence. Nevertheless, by applying the model framework (in cooperation with state-of-the-art models) with various input parameters egress times can be narrowed to a range of possible times.

The case study narrowed the egress time to the range between 167 and 293 seconds. This means, that the egress times may vary by 30 % (ca. one minute) from the mean time when the wayfinding strategies are changed. This variation is not as large as for buildings that contain much more decision points e.g. museums. A similar case study in an american museum yielded to a variation of approximately 75 % of the mean evacuation time [Andresen et al., 2016]. Nevertheless, the variation is still remarkable and needs to be considered. One minute can be vital in an evacuation, for example in case of propagating smoke.

By Famers and Messerer [2008] it is recommended that people have evacuated before the fire fighters arrive at the facility. So, the fire fighters can start extinguishing the fires and search for left people. In german cities the fire fighters are supposed to arrive at the facility within 8 minutes [Arbeitsgemeinschaft der Leiter der Berufsfeuerwehren in der Bundesrepublik Deutschland, 2015]. All egress times within the resulting range are under 5 minutes and therefore acceptable.

It has to be noted that the discussed egress times resulted from a case study that has been conducted under the consideration of certain assumptions. For example, it has been assumed that all persons start their evacuation immediately. In fact, it is more likely that for some reasons certain people do not evacuate right after an emergency announcement has been given. In addition, the assumed number of persons in the station may be incorrect as passengers in arriving trains are not considered. For a comprehensive and reliable assessment of the egress times these fact have to be taken into account.



**Part V**

**Conclusion and Outlook**

---

# Chapter 10

## Closing Remarks

### 10.1 Summary and conclusions

Still many state-of-the-art software frameworks for evacuation simulations determine the routes that are used by the agents without taking into account human wayfinding abilities. Partially, the underlying route choice models imply the assumption that each of the modeled pedestrians are able to plan the shortest route from their position to the outside. However, particularly in complex buildings, people might be present who are not able to plan a route to the outside since they, for example, do not know the locations of exits. These persons or rather their restricted abilities are not considered in the frameworks.

In order to close this gap, a novel model framework has been introduced considering the wayfinding tools and strategies of people who are not or only partially familiar with the facility. This model framework enables agents to make their route choice decisions based on environmental circumstances, individual preferences, spatial memories, and generalized knowledge. For each of the agents and in each timestep the actual isovist is generated which represents the agent's currently visible area. By evaluating its isovist an agent is capable of identifying possible ways (crossings) to proceed. Given the case multiple crossings are available, the agent chooses one of the candidates under consideration of signage and its spatial and generalized knowledge degree. Furthermore, the agent is able to identify and avoid areas it already visited.

In principle, spatial knowledge about an environment is assumed to be incomplete and inaccurate. It can be not even more than a vague idea about a location relative to the own position. For this purpose, a representation of human partial and inaccurate spatial knowledge, the cognitive map, has been introduced. It allows to model degrees of spatial knowledge from no through comprehensive knowledge. To consider the inaccuracy in the spatial memories, positions of objects in the cognitive



map representation are described by ellipses. Agents use the information about the ellipses to decide which of the available crossings are the best choice to reach their desired destination.

Shape, size, and position of an ellipse can be altered arbitrarily. The real position of an object does not necessarily have to be in the ellipse's area. This means, the ellipse in the cognitive map can be apart from the real object. This can make an agent deviate from the direct route to the object or even make it move to a wrong direction.

Additionally, agents are able to distinguish between types of rooms. They prefer stairs and circulation rooms to move more efficiently to an exit.

Agents are furthermore capable of recognizing visible signage and of understanding the instruction that a sign indicates. Studies from the literature have shown that some people fail to perceive signage although it is clearly visible to them. In consequence, a probabilistic model has been introduced that determines if an agent perceives a specific sign. The model takes into account whether and how many signs have been detected previously.

Studies from the literature turned out that the completion of a wayfinding task is partially accomplished by applying multiple wayfinding tools simultaneously. Therefore, the model framework incorporates a functionality to use combinations of modeled wayfinding tools.

Three different wayfinding studies have been conducted in order to investigate selected wayfinding aspects and to calibrate and test the modeling approaches.

The first study took place in an office building. The purpose of the study was to investigate the subjects' route choices in dependency on their familiarity with the building. It showed that participants who possessed profound but not comprehensive knowledge preferred a familiar "safe" path which they use everyday. Participants who were owning profound knowledge decided to head for the shortest possible path. In contrast, unfamiliar subjects chose randomly or based their decisions on environmental factors such as differences in light. Subjects used circulation rooms (corridors) to evacuate without exception.

The study's results were used to calibrate the cognitive map model that has been introduced in this work. It has been shown that, with the help of the calibrated model, it is possible to reproduce the route choice distribution that resulted from the study with a good accuracy. This suggests that the model framework, in comparison to shortest path models, random choice models, and the nearest door heuristic, is more suitable to predict route choice decisions of a group of people if their knowledge

degrees are known. However, the model framework only has been applied to reproduce the route choices of the study. The model neither has been examined in the context of other buildings or facilities nor for other compositions of knowledge degrees. Thus, a general applicability of the model can not be guaranteed yet.

The other two studies have been executed in a german subway station and in a virtual replica of that station, respectively. Purpose of the studies was to identify wayfinding tools and strategies that are applied in subway stations. Particularly, it was of interest to quantify the influence of exit signage. Both studies revealed that the strategy to use an upleading staircase, partially in combination with other strategies, was prevalent among all participants (with one exception). Against this, the results of the two studies differ in terms of the number of participants that used exit signage. In the field study ca. 75% of the subjects perceived and followed signage at the first decision point. In contrast, in the virtual reality study the majority (ca. 90%) ignored signage at this point. It is assumed that the differences are mainly caused by the technical restrictions of the VR-study in terms of the visibility of the virtual environment.

The results of the field study were utilized in order to calibrate the sign recognition model. Subsequently, it has been demonstrated that the calibrated model is able to reproduce the field study's route choice distribution at the first decision point. In how far the calibrated model can be used to predict route choice distributions in other facilities or even in other subway stations has not been investigated. Consequently, a general applicability of the model cannot be ensured yet. The parameter  $P$  that describes the probability to perceive the first visible sign most likely has to be redefined if signage properties and environmental factors change noticeably.

Both the cognitive map model and the signage recognition model are accompanied by the disadvantage that it is difficult to determine the input for the models. In order to apply the cognitive map model, the knowledge degrees of the modeled pedestrians have to be known. For the signage recognition model the parameter  $P$  needs to be determined. The execution of studies and surveys in the regarded facility can solve this issue. However, studies and surveys are accompanied with effort. In some cases they are not feasible at all, for example in buildings that are planned but not built yet. Here, assumption have to be made about the persons' knowledge degrees and their willingness to consider signage. In some cases these assumptions can be made under the consideration of gathered data of similar buildings.

The model framework might not be ready to predict egress times accurately. This is due to the fact, that not all relevant wayfinding strategies are considered and the

existing model parts are not tested for a generic applicability. Moreover, the concept or idea of the cognitive map and generalized knowledge as tools people use to find their ways are also only models whose agreement with the reality is not proven. However, the study in the office building showed that the cognitive map model in combination with the implementation of generalized knowledge can reproduce route choices of people remarkably better than other selected state-of-the-art route choice models.

With the help of the model it is possible to conduct a case study such as the one that has been discussed in this thesis. Such a case study provides the possibility to determine a range of possible egress times that helps to narrow the actual egress times. The range also allows for identifying the strategy that is related to the highest evacuation time and thus allows for worst-case estimations. The range has been set up by applying the here presented model parts and other route choice model from the literature with various parametrizations.

Besides, with the help of the models the influence of various wayfinding strategies on the evacuation progress can be evaluated. Particularly, the effect of signs or salient landmarks on the evacuation progress can be assessed by using the model framework.

Beside the advantages that the model framework provides for the design and assessment of buildings the modeling approaches and certainly also the presented studies give new insights about tools and strategies involved in the human wayfinding process and thus open new discussions about wayfinding in various scientific fields.

## 10.2 Outlook

The model framework covers all wayfinding tools for individually moving pedestrians that have been mentioned in the literature. Though, the herding effect which may have a remarkable impact on the route choice is not taken into account. Generally, agents of the framework do not consider the presence of other agents, let alone the others' route choices. This also means that the simulated pedestrians do not identify jams in front of high frequented doorways and reroute via alternative routes. This applies also for the identification of propagating smoke and environmental factors such as differences in brightness and size of rooms or corridors.

Conveniently, the structure of the model framework allows for extensions by new parts. Thus, it is planned to integrate further models that consider the movements of other people or smoke into the framework. As single entities these models partially

already exist (see for example Schröder et al. [2015]; Kemloh Wagoum, Armel Ulrich [2013]).

The high computational effort that is related to the application of the presented framework is still an issue. Especially the long execution time discourages users to apply the framework for their purposes. In order to counteract this issue, it is planned to use MPI or other kinds of parallelization in the future so that also a high number of simulations with a lot of pedestrians can be accomplished in acceptable time.



Part VI  
Appendices

---

# Appendix A

## Route distribution that resulted from the cognitive map model

Table A.1: Results from the simulation in the office building of Research Center Jülich. Distribution of routes that were chosen by the agents in consideration of their knowledge degree.

Route / Knowledge degree	1	2	3	4	5	6	7	8	9	10	Total
Route A	15	5	8	11	7	5	32	51	8	4	146
Route B	5	3	1	4	3	1	6	2	0	0	25
Route C	5	2	0	2	2	2	15	64	42	36	16
Route D	1	1	0	1	1	0	0	0	0	0	4
Route E	0	2	1	0	1	0	0	0	0	0	4
Route F	1	1	0	1	0	0	0	0	0	0	3
Route G	3	1	3	1	0	0	0	0	0	0	8
Route H	2	1	3	2	0	1	0	0	0	0	9
Route I	2	2	0	2	1	0	0	2	0	0	9
Route J	4	3	1	2	0	0	0	0	0	0	10
Route K	7	4	4	4	3	0	7	7	0	0	36
Route L	5	5	9	10	2	1	10	4	0	0	46
Sum	50	30	30	40	20	10	70	130	50	40	470



# Appendix B

## Case study - Used geometry

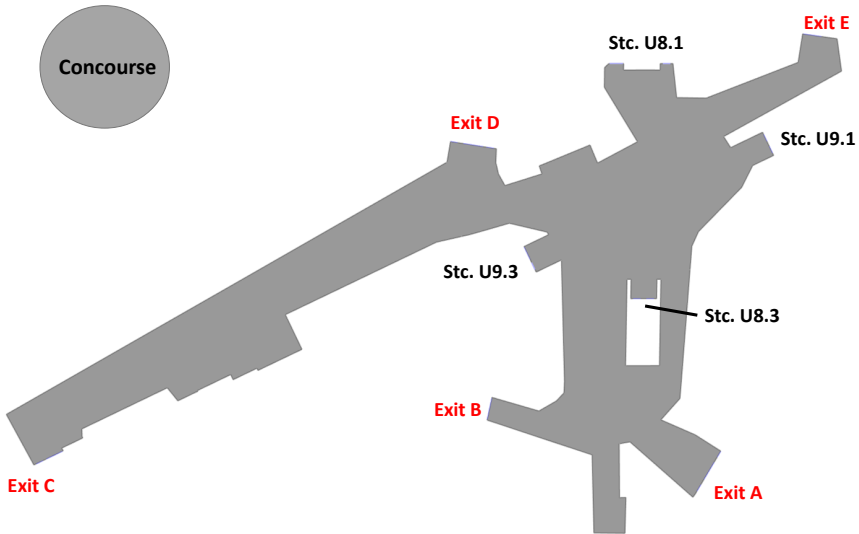

Figure B.1: The simplified floor plan of the subway station's concourse level that has been used in the context of the case study discussed in Chapter 9.

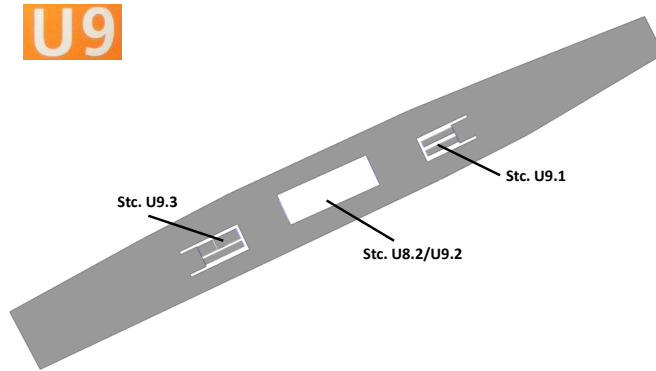

Figure B.2: The simplified floor plan of Platform U9 that has been used in the context of the case study discussed in Chapter 9.

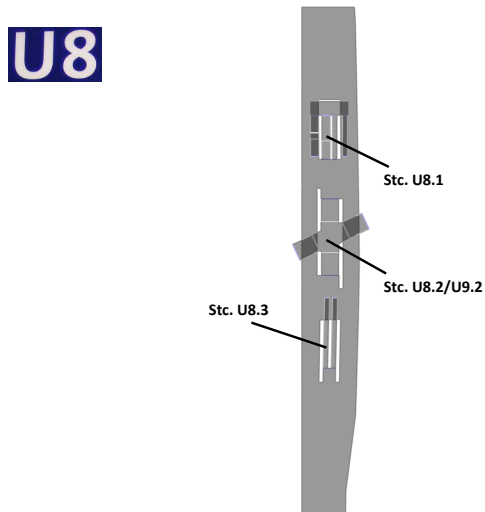

Figure B.3: The simplified floor plan of Platform U8 that has been used in the context of the case study discussed in Chapter 9.

# Appendix C

## Case study - Initial conditions

In the context of the case study (see Chapter 9) the following xml-files have been used to set-up and execute simulation runs of Scenario D (Collaboration of strategies). If the reader is interested in further files that i.a. show the initial conditions of the other scenarios, he/she is referred to Andresen [2018].

### JPS-Inifile

```
<?xml version="1.0" encoding="UTF-8"?>
<JuPedSim project="subwaystation" version="0.8" xmlns:xsi="
  http://www.w3.org/2001/XMLSchema-instance" xsi:
  noNamespaceSchemaLocation="../../xsd/jps_ini_core.xsd">
  <!-- header: seed, geometry, output format -->
  <seed>33708</seed>
  <max_sim_time>450</max_sim_time>
  <show_statistics>>true</show_statistics>
  <!--maxCPU>1</maxCPU-->
  <num_threads>1</num_threads>
  <geometry>../../geo.xml</geometry>
  <!-- traectories file and format -->
  <trajectories format="xml-plain" fps="10">
    <file location="./traj.xml" />
  </trajectories>
  <!-- agents -->
  <agents operational_model_id="3">
    <agents_distribution>
      <group group_id="0" agent_parameter_id="1" room_id="0"
        subroom_id="1" number="25" router_id="7" />
      <group group_id="100" agent_parameter_id="1" room_id="0"
        subroom_id="1" number="25" router_id="7" />

      <group group_id="3" agent_parameter_id="1" room_id="0"
        subroom_id="2" number="10" router_id="7" />
    </agents_distribution>
  </agents>
</JuPedSim>
```

## APPENDIX C. CASE STUDY - INITIAL CONDITIONS

---

```
<group group_id="300" agent_parameter_id="1" room_id
    ="0" subroom_id="2" number="10" router_id="7" />

<group group_id="4" agent_parameter_id="1" room_id="0"
    subroom_id="3" number="10" router_id="7" />
    <group group_id="400" agent_parameter_id="1" room_id
        ="0" subroom_id="3" number="10" router_id="7" />

<group group_id="5" agent_parameter_id="1" room_id="0"
    subroom_id="4" number="25" router_id="7" />
    <group group_id="500" agent_parameter_id="1" room_id
        ="0" subroom_id="4" number="25" router_id="7" />

<group group_id="6" agent_parameter_id="1" room_id="0"
    subroom_id="5" number="25" router_id="7" />
    <group group_id="600" agent_parameter_id="1" room_id
        ="0" subroom_id="5" number="25" router_id="7" />

<group group_id="7" agent_parameter_id="1" room_id="0"
    subroom_id="6" number="25" router_id="7" />
    <group group_id="700" agent_parameter_id="1" room_id
        ="0" subroom_id="6" number="25" router_id="7" />

<group group_id="8" agent_parameter_id="1" room_id="1"
    subroom_id="0" number="4" router_id="7" />
<group group_id="9" agent_parameter_id="1" room_id="1"
    subroom_id="1" number="4" router_id="7" />
<group group_id="10" agent_parameter_id="1" room_id="1"
    subroom_id="2" number="4" router_id="7" />
<group group_id="11" agent_parameter_id="1" room_id="1"
    subroom_id="3" number="4" router_id="7" />
<group group_id="12" agent_parameter_id="1" room_id="1"
    subroom_id="4" number="4" router_id="7" />
<group group_id="13" agent_parameter_id="1" room_id="2"
    subroom_id="0" number="4" router_id="7" />
<group group_id="14" agent_parameter_id="1" room_id="2"
    subroom_id="1" number="4" router_id="7" />
<group group_id="15" agent_parameter_id="1" room_id="3"
    subroom_id="0" number="4" router_id="7" />
<group group_id="16" agent_parameter_id="1" room_id="3"
    subroom_id="1" number="4" router_id="7" />
<group group_id="17" agent_parameter_id="1" room_id="3"
    subroom_id="2" number="4" router_id="7" />
<group group_id="18" agent_parameter_id="1" room_id="3"
    subroom_id="3" number="4" router_id="7" />
<group group_id="19" agent_parameter_id="1" room_id="4"
    subroom_id="0" number="4" router_id="7" />
```

---

```
<group group_id="20" agent_parameter_id="1" room_id="5"
  subroom_id="0" number="4" router_id="7" />
<group group_id="21" agent_parameter_id="1" room_id="5"
  subroom_id="1" number="2" router_id="7" />
<group group_id="22" agent_parameter_id="1" room_id="5"
  subroom_id="2" number="4" router_id="7" />
<group group_id="23" agent_parameter_id="1" room_id="5"
  subroom_id="3" number="4" router_id="7" />

<group group_id="24" agent_parameter_id="1" room_id="6"
  subroom_id="0" number="15" router_id="7" />
  <group group_id="240" agent_parameter_id="1" room_id
    ="6" subroom_id="0" number="15" router_id="7" />

<group group_id="39" agent_parameter_id="1" room_id="6"
  subroom_id="1" number="18" router_id="7" />
  <group group_id="390" agent_parameter_id="1" room_id
    ="6" subroom_id="1" number="17" router_id="7" />

<group group_id="25" agent_parameter_id="1" room_id="6"
  subroom_id="2" number="8" router_id="7" />
  <group group_id="250" agent_parameter_id="1" room_id
    ="6" subroom_id="2" number="7" router_id="7" />

<group group_id="26" agent_parameter_id="1" room_id="6"
  subroom_id="3" number="7" router_id="7" />
  <group group_id="260" agent_parameter_id="1" room_id
    ="6" subroom_id="3" number="8" router_id="7" />

<group group_id="27" agent_parameter_id="1" room_id="6"
  subroom_id="4" number="17" router_id="7" />
  <group group_id="270" agent_parameter_id="1" room_id
    ="6" subroom_id="4" number="18" router_id="7" />

<group group_id="28" agent_parameter_id="1" room_id="6"
  subroom_id="5" number="15" router_id="7" />
  <group group_id="280" agent_parameter_id="1" room_id
    ="6" subroom_id="5" number="15" router_id="7" />

<group group_id="29" agent_parameter_id="1" room_id="7"
  subroom_id="0" number="4" router_id="7" />
<group group_id="30" agent_parameter_id="1" room_id="8"
  subroom_id="0" number="2" router_id="7" />
<group group_id="31" agent_parameter_id="1" room_id="9"
  subroom_id="0" number="4" router_id="7" />
<group group_id="32" agent_parameter_id="1" room_id="10"
  subroom_id="0" number="4" router_id="7" />
```

```
<group group_id="33" agent_parameter_id="1" room_id="10"
  subroom_id="2" number="4" router_id="7" />
<group group_id="34" agent_parameter_id="1" room_id="11"
  subroom_id="1" number="34" router_id="7" />
<group group_id="35" agent_parameter_id="1" room_id="11"
  subroom_id="2" number="34" router_id="7" />
<group group_id="36" agent_parameter_id="1" room_id="11"
  subroom_id="3" number="34" router_id="7" />
<group group_id="37" agent_parameter_id="1" room_id="11"
  subroom_id="4" number="34" router_id="7" />
<group group_id="38" agent_parameter_id="1" room_id="11"
  subroom_id="0" number="34" router_id="7" />
</agents_distribution>
</agents>
<!-- operational models -->
<operational_models>
  <model operational_model_id="3" description="Tordeux2015">
    <model_parameters>
      <solver>euler</solver>
      <stepsize>0.1</stepsize>
      <periodic>0</periodic>
      <exit_crossing_strategy>1</exit_crossing_strategy>
      <linkedcells enabled="true" cell_size="30" />
      <force_ped a="5" D="0.1" />
      <force_wall a="6" D="0.2" />
    </model_parameters>
    <agent_parameters agent_parameter_id="1">
      <v0 mu="1.34" sigma="0.0" />
      <v0_idle_escalator_upstairs mu="0.6" sigma="0.0" />
      <v0_idle_escalator_downstairs mu="0.6" sigma="0.0" />
      <bmax mu="0.15" sigma="0.0" />
      <bmin mu="0.15" sigma="0.0" />
      <amin mu="0.15" sigma="0.0" />
      <tau mu="0.5" sigma="0.0" />
      <atau mu="0." sigma="0.0" />
      <T mu="1" sigma="0.0" />
    </agent_parameters>
  </model>
</operational_models>
<!-- route choice models -->
<route_choice_models>
  <router router_id="7" description="AI">
    <cognitive_map files="../cogmap.xml" />
    <signage file="../signage.xml" />
  </router>
</route_choice_models>
</JuPedSim>
```

---

## Cognitive Map

```
<?xml version="1.0" encoding="UTF-8" standalone="yes"?>
<cognitiveMap version="0.81" caption="cogMap" xmlns:xsi="http
  ://www.w3.org/2001/XMLSchema-instance" xsi:
  noNamespaceSchemaLocation="http://xsd.jupedsim.org/
  jps_geometry.xsd" unit="m">
  <regions>
    <region id="0" caption="Region0" px="22.8772" py="
      45.0156" a="48.9075" b="38.2634">
      <landmarks>
        <landmark id="0" caption="Landmark0" type="
          main" room1_id="0" subroom1_id="1" pxreal="
            9.3" pyreal="73.0" px="9.3" py="73.0" a="
              2.01265" b="1.06286">
              <associations/>
            </landmark>
          <landmark id="1" caption="Landmark1" type="
            main" room1_id="0" subroom1_id="1" pxreal="
              8.5" pyreal="21.0" px="8.5" py="21.0" a="
                1.62914" b="1.09256">
                <associations/>
              </landmark>
            </landmarks>
          <connections/>
        </region>
      </regions>
    </cognitiveMap>
```

## Signage

```
<?xml version="1.0" encoding="UTF-8" standalone="yes"?>
<signage version="0.81" caption="signage" xmlns:xsi="http://
  www.w3.org/2001/XMLSchema-instance" xsi:
  noNamespaceSchemaLocation="http://xsd.jupedsim.org/
  jps_geometry.xsd" unit="m">
  <signs>
    <!--U8/-->
    <sign id="0" caption="yellow_black_exit_sign"
      room_id="0" px="6.5" py="82.0"
      alphaPointing="270.0" alpha="180.0" />
    <sign id="1" caption="yellow_black_exit_sign"
      room_id="0" px="11.7" py="82.0"
      alphaPointing="270.0" alpha="0.0" />
    <sign id="2" caption="yellow_black_exit_sign"
      room_id="0" px="9.2" py="76.5"
      alphaPointing="90.0" alpha="270.0" />
    <sign id="3" caption="yellow_black_exit_sign"
      room_id="0" px="6.25" py="63.75"
      alphaPointing="90.0" alpha="180.0" />
    <sign id="4" caption="yellow_black_exit_sign"
      room_id="0" px="12.5" py="54.5"
      alphaPointing="270.0" alpha="0.0" />
    <sign id="5" caption="yellow_black_exit_sign"
      room_id="0" px="6.5" py="34.0"
      alphaPointing="270.0" alpha="180.0" />
    <sign id="6" caption="yellow_black_exit_sign"
      room_id="0" px="11.5" py="34.0"
      alphaPointing="270.0" alpha="0.0" />
    <sign id="7" caption="yellow_black_exit_sign"
      room_id="0" px="9.0" py="29.5"
      alphaPointing="90.0" alpha="270.0" />
    <!--U9/-->
    <sign id="8" caption="yellow_black_exit_sign"
      room_id="6" px="-12.6" py="48.75"
      alphaPointing="24.0" alpha="204.0" />
    <sign id="9" caption="yellow_black_exit_sign"
      room_id="6" px="-8.1" py="48.0"
      alphaPointing="204.0" alpha="284.0" />
    <sign id="10" caption="yellow_black_exit_sign"
      room_id="6" px="-10.65" py="53.0"
      alphaPointing="204.0" alpha="114.0" />
    <sign id="11" caption="yellow_black_exit_sign"
      room_id="6" px="8.15" py="56.15"
      alphaPointing="204.0" alpha="284.0" />
    <sign id="12" caption="yellow_black_exit_sign"
      room_id="6" px="4.8" py="62.0"
```



---

```

        alphaPointing="204.0" alpha="114.0" />
<sign id="13" caption="yellow_black_exit_sign"
    room_id="6" px="31.0" py="66.8"
    alphaPointing="24.0" alpha="284.0" />
<sign id="14" caption="yellow_black_exit_sign"
    room_id="6" px="27.2" py="70.8"
    alphaPointing="24.0" alpha="114.0" />
<sign id="15" caption="yellow_black_exit_sign"
    room_id="6" px="31.3" py="70.0"
    alphaPointing="204.0" alpha="24.0" />
<!--Concourse-->
<sign id="16" caption="yellow_black_exit_sign"
    room_id="11" px="10.5" py="70.0"
    alphaPointing="180.0" alpha="90.0" />
<sign id="16" caption="yellow_black_exit_sign"
    room_id="11" px="11.5" py="70.0"
    alphaPointing="0.0" alpha="90.0" />
<sign id="17" caption="yellow_black_exit_sign"
    room_id="11" px="22.5" py="72.5"
    alphaPointing="24.0" alpha="204.0" />
<sign id="18" caption="yellow_black_exit_sign"
    room_id="11" px="21.5" py="65.5"
    alphaPointing="114.0" alpha="24.0" />
<sign id="19" caption="yellow_black_exit_sign"
    room_id="11" px="22.5" py="65.5"
    alphaPointing="294.0" alpha="24.0" />
<sign id="20" caption="yellow_black_exit_sign"
    room_id="11" px="13.5" py="46.0"
    alphaPointing="270.0" alpha="90.0" />
<sign id="21" caption="yellow_black_exit_sign"
    room_id="11" px="3.0" py="43.8"
    alphaPointing="270.0" alpha="90.0" />
<sign id="22" caption="yellow_black_exit_sign"
    room_id="11" px="6.5" py="30.0"
    alphaPointing="0.0" alpha="90.0" />
<sign id="23" caption="yellow_black_exit_sign"
    room_id="11" px="-1.5" py="54.5"
    alphaPointing="114.0" alpha="204.0" />
<sign id="23" caption="yellow_black_exit_sign"
    room_id="11" px="-1.5" py="53.5"
    alphaPointing="294.0" alpha="204.0" />
<sign id="24" caption="yellow_black_exit_sign"
    room_id="11" px="-11.0" py="60.0"
    alphaPointing="90.0" alpha="0.0" />
<sign id="25" caption="yellow_black_exit_sign"
    room_id="11" px="9.35" py="50.0"
    alphaPointing="180.0" alpha="270.0" />

```

```
<sign id="26" caption="yellow_black_exit_sign"  
      room_id="11" px="9.45" py="50.0"  
      alphaPointing="0.0" alpha="270.0" />  
</signs>  
</signage>
```

---

# References

- Allen, G. L. (1999). Spatial abilities, cognitive maps, and wayfinding. In Golledge, R. G., editor, *Wayfinding behavior*, pages 46–80. Johns Hopkins University Press, Baltimore.
- Anderson, J. R. (2010). *Cognitive psychology and its implications*. Worth Publishers, New York, 7th ed. edition.
- Andresen, E. (2016). Representation of wayfinding and perception abilities in agent-based models. In Thomas Barkowsky, Zoe Falomir Llansola, H. S. and van de Ven, J., editors, *Proceedings of the 13th Biannual Conference of the German Cognitive Science Society*, pages 237–240.
- Andresen, E. (2018). JuPedSim Artificial Intelligence Routing Framework. doi:10.5281/zenodo.1158353.
- Andresen, E., Chraibi, M., and Seyfried, A. (2016). The impact of perception and wayfinding on pedestrian movements. In *Proceedings of Pedestrian and Evacuation Dynamics 2016*. University of Science and Technology of China Press.
- Andresen, E., Chraibi, M., and Seyfried, A. (2018). A representation of partial spatial knowledge: A cognitive map approach for evacuation simulations. *Transportmetrica A: Transport Science*, 0(ja):1–34, doi:10.1080/23249935.2018.1432717.
- Appleyard, D. (1969). Why buildings are known: A predictive tool for architects and planners. *Environment and Behavior*, 1(2):131–156, doi:10.1177/001391656900100202.
- Arbeitsgemeinschaft der Leiter der Berufsfeuerwehren in der Bundesrepublik Deutschland (2015). Qualitätskriterien für die Bedarfsplanung von Feuerwehren in Städten: Empfehlungen der Arbeitsgemeinschaft der Leiter der Berufsfeuerwehren.

- 
- Arthur, P. and Passini, R. (1992). *Wayfinding: People, signs, and architecture*. McGraw-Hill Book Co, New York.
- Asano, M., Iryo, T., and Kuwahara, M. (2010). Microscopic pedestrian simulation model combined with a tactical model for route choice behaviour. *Transportation Research Part C: Emerging Technologies*, 18(6):842 – 855, doi:10.1016/j.trc.2010.01.005. Special issue on Transportation Simulation Advances in Air Transportation Research.
- Beeson, P., Modayil, J., and Kuipers, B. (2010). Factoring the mapping problem: Mobile robot map-building in the hybrid spatial semantic hierarchy. *The International Journal of Robotics Research*, 29(4):428–459, doi:10.1177/0278364909100586.
- Benthorn, L. and Frantzich, H. (1999). Fire alarm in a public building: How do people evaluate information and choose an evacuation exit? *Fire and Materials*, 23(6):311–315, doi:10.1002/(SICI)1099-1018(199911/12)23:6<311::AID-FAM704>3.0.CO;2-J.
- Blue, V. J. and Adler, J. L. (2001). Cellular automata microsimulation for modeling bi-directional pedestrian walkways. *Transportation Research Part B: Methodological*, 35(3):293–312, doi:10.1016/S0191-2615(99)00052-1.
- Bode, Nikolai W.F., Kemloh Wagoum, Armel U., and Codling, E. A. (2014). Human responses to multiple sources of directional information in virtual crowd evacuations. *Journal of the Royal Society, Interface / the Royal Society*, 11(91):20130904, doi:10.1098/rsif.2013.0904.
- Bohbot, V. D., Lerch, J., Thorndycraft, B., Iaria, G., and Zijdenbos, A. P. (2007). Gray matter differences correlate with spontaneous strategies in a human virtual navigation task. *The Journal of neuroscience : the official journal of the Society for Neuroscience*, 27(38):10078–10083, doi:10.1523/JNEUROSCI.1763-07.2007.
- Burgess, N., Jackson, A., Hartley, T., and O’Keefe, J. (2000). Predictions derived from modelling the hippocampal role in navigation. *Biological cybernetics*, 83(3):301–312.
- Burghardt, S. (2013). *Dynamik von Personenströmen in Sportstadien*, volume 18 of *IAS Series*. Forschungszentrum Jülich.

## REFERENCES

---

- Buribayev, Aydar (29.03.2010). Suicide bombers kill at least 38 in moscow subway. URL: <https://web.archive.org/web/20100401081142/https://www.reuters.com/article/idUSTRE62S0FM20100329>; Retrieved 06.12.2017.
- Cao, S., Zhang, J., Salden, D., and Ma, J. (2016). Fundamental diagrams of single-file pedestrian flow for different age groups. In Tan, Y., Shi, Y., and Niu, B., editors, *Advances in Swarm Intelligence: 7th International Conference, ICSI 2016, Bali, Indonesia, June 25-30, 2016, Proceedings, Part I*, pages 154–161. Springer International Publishing, Cham.
- Carlson, L. A., Hölscher, C., Shipley, T. F., and Dalton, R. C. (2010). Getting lost in buildings. *Current Directions in Psychological Science*, 19(5):284–289, doi:10.1177/0963721410383243.
- Chattaraj, U., Seyfried, A., and Chakroborty, P. (2009). Comparison of pedestrian fundamental diagram across cultures. *Advances in Complex Systems*, 12(03):393–405, doi:10.1142/S0219525909002209.
- Chraïbi, M., Schadschneider, A., and Seyfried, A. (2013). *On Force-Based Modeling of Pedestrian Dynamics*, pages 23–41. Springer New York, New York, NY.
- Chraïbi, M., Seyfried, A., and Schadschneider, A. (2010). Generalized centrifugal-force model for pedestrian dynamics. *Physical Review E*, 82(4), doi:10.1103/PhysRevE.82.046111.
- CNN Wire Staff (25.09.2017). Government decreases death toll in cambodian stampede. URL: <http://edition.cnn.com/2010/WORLD/asiapcf/11/25/cambodia.festival.deaths/index.html>; Retrieved 06.12.2017.
- Dagnelie, G. (2011). *Visual Prosthetics*. Springer US, Boston, MA.
- Dijkstra, E. W. (1959). A note on two problems in connexion with graphs. *Numerische Mathematik*, 1(1):269–271.
- Downs, R. M. and Stea, D. (2005). *Image & environment: Cognitive mapping and spatial behavior*. Transaction Publishers, New Brunswick, N.J.
- Duarte, E., Rebelo, F., Teles, J., and Wogalter, M. S. (2014). Behavioral compliance for dynamic versus static signs in an immersive virtual environment. *Applied ergonomics*, 45(5):1367–1375, doi:10.1016/j.apergo.2013.10.004.

- 
- Ehtamo, H., Heliövaara, S., Hostikka, S., and Korhonen, T. (2010). Modeling evacuees' exit selection with best response dynamics. In Klingsch, W., editor, *Pedestrian and evacuation dynamics 2008*, pages 309–319. Springer, Berlin and Heidelberg.
- Ekstrom, A. D., Kahana, M. J., Caplan, J. B., Fields, T. A., Isham, E. A., Newman, E. L., and Fried, I. (2003). Cellular networks underlying human spatial navigation. *Nature*, 425(6954):184–188, doi:10.1038/nature01964.
- Ellard, C. (2009). *You Are Here: Why We Can Find Our Way to the Moon, but Get Lost in the Mall*. Knopf Doubleday Publishing Group.
- Famers, G. and Messerer, J. (2008). Rettung von Personen und wirksame Löscharbeiten - bauordnungsrechtliche Schutzziele mit Blick auf die Entrauchung.
- Filippidis, L. (2006). Representing the influence of signage on evacuation behavior within an evacuation model. *Journal of Fire Protection Engineering*, 16(1):37–73, doi:10.1177/1042391506054298.
- Forschungsgesellschaft für Straßen- und Verkehrswesen (2009). *Handbuch für die Bemessung von Strassenverkehrsanlagen: HBS*, volume 299 of *FGSV*. FGSV-Verl., Köln, 2009 edition.
- Galea, E., Xie, H., and Lawrence, P. (2014). Experimental and survey studies on the effectiveness of dynamic signage systems. *Fire Safety Science*, 11:1129–1143, doi:10.3801/IAFSS.FSS.11-1129.
- Gärling, T., Lindberg, E., Carreiras, M., and Anders, B. (1986). Reference systems in cognitive maps. *Journal of Environmental Psychology*, 6(1):1–18, doi:10.1016/S0272-4944(86)80031-7.
- Golledge, R. G., editor (1999). *Wayfinding behavior: Cognitive mapping and other spatial processes*. Johns Hopkins University Press, Baltimore.
- Golledge, R. G. and Spector, A. N. (1978). Comprehending the urban environment: Theory and practice. *Geographical Analysis*, 10(4):403–426, doi:10.1111/j.1538-4632.1978.tb00667.x.
- Gopal, S., Klatzky, R. L., and Smith, T. R. (1989). Navigator: A psychologically based model of environmental learning through navigation. *Journal of Environmental Psychology*, 9(4):309–331, doi:10.1016/S0272-4944(89)80012-X.

## REFERENCES

---

- Griffin, A. (15.09.2017). Parsons green explosion: 'many injured' in stampede as people flee reported blast at london station. URL: <http://www.independent.co.uk/news/uk/home-news/parsons-green-explosion-incident-injuries-stampede-commuters-tube-underground-a7947816.html>; Retrieved 06.12.2017.
- Grosshandler, W. L., Bryner, N. P., Madrzykowski, D. M., and Kuntz, K. (2005). Report of the technical investigation of the station nightclub fire (nist ncstar 2), volume 1. *National Construction Safety Team Act Reports (NIST NCSTAR) - 2*.
- Guo, R.-Y. and Huang, H.-J. (2011). Route choice in pedestrian evacuation: Formulated using a potential field. *Journal of Statistical Mechanics: Theory and Experiment*, 2011(04):P04018, doi:10.1088/1742-5468/2011/04/P04018.
- Hedda Nier (2017). Das große Pendeln. URL: <https://de.statista.com/infografik/8781/deutsche-grossstaedte-nach-anzahl-der-pendelnden-beschaeftigten/>; Retrieved 06.12.2017.
- Helbing, D., Farkas, I., and Vicsek, T. (2000). Simulating dynamical features of escape panic. *Nature*, 407(6803):487–490, doi:10.1038/35035023.
- Helbing, D., Farkas, I. J., Molnar, P., and Vicsek, T. (2002). Simulation of pedestrian crowds in normal and evacuation situations. *Pedestrian and evacuation dynamics*, 21(2):21–58.
- Helbing, D. and Johansson, A. (2010). Pedestrian, crowd, and evacuation dynamics. *Encyclopedia of Complexity and Systems Science*, 16:6476–6495.
- Helbing, D. and Molnár, P. (1995). Social force model for pedestrian dynamics. *Physical Review E*, 51(5):4282–4286, doi:10.1103/PhysRevE.51.4282.
- Hirai, K. and Tarui, K. (1977). A simulation of the behavior of a crowd in panic. *Systems and Control, Japan*.
- Hofinger, G., Zinke, R., Schröder, B., Andresen, E., and Künzer, L. (2016). Human factors in pedestrian simulation: Field studies in underground stations. In *Proceedings of Pedestrian and Evacuation Dynamics 2016*, pages 41–48. University of Science and Technology of China Press.



- 
- Hoogendoorn, S. P., Luding, S., Bovy, P. H. L., Schreckenberg, M., and Wolf, D. E., editors (2005). *Traffic and Granular Flow '03*. Springer Berlin Heidelberg, Berlin, Heidelberg.
- Hund, A. M. and Minarik, J. L. (2006). Getting from here to there: Spatial anxiety, wayfinding strategies, direction type, and wayfinding efficiency. *Spatial Cognition & Computation*, 6(3):179–201, doi:10.1207/s15427633scc0603\_1.
- Hurlebaus, R., Basten, K., Mallot, H. A., and Wiener, J. M. (2008). Route learning strategies in a virtual cluttered environment. In Freksa, C., Newcombe, N. S., Gärdenfors, P., and Wöfl, S., editors, *Spatial Cognition VI. Learning, Reasoning, and Talking about Space*, volume 5248 of *Lecture Notes in Computer Science*, pages 104–120. Springer Berlin Heidelberg, Berlin, Heidelberg.
- Iaria, G., Petrides, M., Dagher, A., Pike, B., and Bohbot, V. D. (2003). Cognitive strategies dependent on the hippocampus and caudate nucleus in human navigation: variability and change with practice. *The Journal of neuroscience : the official journal of the Society for Neuroscience*, 23(13):5945–5952.
- Jacobs, J., Kahana, M. J., Ekstrom, A. D., Mollison, M. V., and Fried, I. (2010). A sense of direction in human entorhinal cortex. *Proceedings of the National Academy of Sciences of the United States of America*, 107(14):6487–6492, doi:10.1073/pnas.0911213107.
- Kalff, C. and Strube, G. (2009). Background knowledge in human navigation: a study in a supermarket. *Cognitive processing*, 10 Suppl 2:S225–8, doi:10.1007/s10339-009-0287-6.
- Karamouzas, I., Heil, P., van Beek, P., and Overmars, M. H. (2009). A predictive collision avoidance model for pedestrian simulation. In Egges, A., Geraerts, R., and Overmars, M., editors, *Motion in Games*, volume 5884 of *Lecture Notes in Computer Science*, pages 41–52. Springer-Verlag Berlin Heidelberg, Berlin, Heidelberg.
- Karamouzas, I., Sohre, N., Narain, R., and Guy, S. J. (2017). Implicit crowds: Optimization integrator for robust crowd simulation. *ACM Transactions on Graphics*, 36(4), doi:10.1145/3072959.3073705.
- Kemloh, U., Chraïbi, M., and Sesser, F. (2016). Jupedsim/jupedsim: Jupedsim v0.8.1. doi:10.5281/zenodo.160168.

## REFERENCES

---

- Kemloh Wagoum, Armel Ulrich (2013). *Route choice modelling and runtime optimisation for simulation of building evacuation*, volume 17 of *IAS Series*. Research Center Jülich.
- Kielar, P. M., Biedermann, D. H., Kneidl, A., and Borrmann, A. (2016). A unified pedestrian routing model combining multiple graph-based navigation methods. In Knoop, V. L. and Daamen, W., editors, *Traffic and Granular Flow '15*, pages 241–248. Springer International Publishing, Cham.
- Kirchner, A. and Schadschneider, A. (2002). Simulation of evacuation processes using a bionics-inspired cellular automaton model for pedestrian dynamics. *Physica A: Statistical Mechanics and its Applications*, 312(1-2):260–276, doi:10.1016/S0378-4371(02)00857-9.
- Klippel, A., Tappe, H., Kulik, L., and Lee, P. U. (2005). Wayfinding choremes—a language for modeling conceptual route knowledge. *Journal of Visual Languages & Computing*, 16(4):311–329, doi:10.1016/j.jvlc.2004.11.004.
- Kneidl, A. (2013). *Methoden zur Abbildung menschlichen Navigationsverhaltens bei der Modellierung von Fußgängerströmen*. PhD thesis, Technische Universität München.
- Kobes, M., Helsloot, I., de Vries, B., Post, J. G., Oberijé, N., and Groenewegen, K. (2010). Way finding during fire evacuation; an analysis of unannounced fire drills in a hotel at night. *Building and Environment*, 45(3):537–548, doi:10.1016/j.buildenv.2009.07.004.
- Kormanová, A. et al. (2014). A review on macroscopic pedestrian flow modelling. *Acta Informatica Pragensia*, 2(2):39–50.
- Kretz, T. (2009). Pedestrian traffic: On the quickest path. *Journal of Statistical Mechanics: Theory and Experiment*, 2009(03):P03012, doi:10.1088/1742-5468/2009/03/P03012.
- Kretz, T., Hengst, S., and Vortisch, P. (2008). Pedestrian flow at bottlenecks - validation and calibration of vissim’s social force model of pedestrian traffic and its empirical foundations. *CoRR*, abs/0805.1788.
- Kretz, T., Mayer, G., and Mühlberger, A. (2011). Behaviour and perception-based pedestrian evacuation simulation. In Peacock, R. D., Kuligowski, E. D., and Averill,

- 
- J. D., editors, *Pedestrian and evacuation dynamics*, pages 827–831. Springer, New York.
- Kretz, T. and Schreckenberg, M. (2006). The F.A.S.T.-Model. In Hutchison, D., Kanade, T., Kittler, J., Kleinberg, J. M., Mattern, F., Mitchell, J. C., Naor, M., Nierstrasz, O., Pandu Rangan, C., Steffen, B., Sudan, M., Terzopoulos, D., Tygar, D., Vardi, M. Y., Weikum, G., El Yacoubi, S., Chopard, B., and Bandini, S., editors, *Cellular Automata*, volume 4173 of *Lecture Notes in Computer Science*, pages 712–715. Springer Berlin Heidelberg, Berlin, Heidelberg.
- Kuipers, B. (1978). Modeling spatial knowledge:. *Cognitive Science*, 2(2):129–153, doi:10.1207/s15516709cog0202\_3.
- Kuipers, B. (2000). The spatial semantic hierarchy. *Artificial Intelligence*, 119(1-2):191–233, doi:10.1016/S0004-3702(00)00017-5.
- Künzer, L., Hofinger, G., and Zinke, R. (2016). The influence of colored running lights on route choice: Dynamic guidance and affordance. In *Proceedings of Pedestrian and Evacuation Dynamics 2016*, pages 184–189. University of Science and Technology of China Press.
- Lawen, Andreas (2017). Festivalgelände - Rock am Ring 2017. URL: [https://de.wikipedia.org/wiki/Rock\\_am\\_Ring](https://de.wikipedia.org/wiki/Rock_am_Ring); Retrived: 30.12.2017.
- Lawton, C. A. (1996). Strategies for indoor wayfinding: The role of orientation. *Journal of Environmental Psychology*, 16(2):137–145, doi:10.1006/jevp.1996.0011.
- Lawton, C. A., Charleston, S. I., and Zieles, A. S. (1996). Individual- and gender-related differences in indoor wayfinding. *Environment and Behavior*, 28(2):204–219, doi:10.1177/0013916596282003.
- Liu, X.-d., Song, W.-g., and Lv, W. (2014). Empirical data for pedestrian counterflow through bottlenecks in the channel. *Transportation Research Procedia*, 2:34–42, doi:10.1016/j.trpro.2014.09.006.
- Løvas, G. G. (1998). Models of wayfinding in emergency evacuations. *European Journal of Operational Research*, 105(3):371–389, doi:10.1016/S0377-2217(97)00084-2.
- Lynch, K. (1960). *The image of the city*. Publication of the Joint Center for Urban Studies. M.I.T. Press, Cambridge, Mass., 15. print edition.

## REFERENCES

---

- Madl, T., Chen, K., Montaldi, D., and Trappl, R. (2015). Computational cognitive models of spatial memory in navigation space: A review. *Neural Networks*, 65:18–43, doi:10.1016/j.neunet.2015.01.002.
- Madl, T., Franklin, S., Chen, K., and Trappl, R. (2013). Spatial working memory in the lida cognitive architecture. In *International conference on cognitive modelling*, pages 384–390.
- Montello, D. R. and Sas, C. (2006). Human factors of wayfinding in navigation. In Karwowski, W., W, editor, *International Encyclopedia of Ergonomics and Human Factors*, pages 2003–2008. CRC Press/Taylor & Francis, Ltd.
- Morley, F. J. (1997). An evaluation of the comprehensibility of graphical exit signs for passenger aircraft.
- Moser, E. I., Kropff, E., and Moser, M.-B. (2008). Place cells, grid cells, and the brain’s spatial representation system. *Annual review of neuroscience*, 31:69–89, doi:10.1146/annurev.neuro.31.061307.090723.
- Moussaïd, M., Kapadia, M., Thrash, T., Sumner, R. W., Gross, M., Helbing, D., and Hölscher, C. (2016). Crowd behaviour during high-stress evacuations in an immersive virtual environment. *Journal of the Royal Society, Interface / the Royal Society*, 13(122), doi:10.1098/rsif.2016.0414.
- Murakoshi, S. and Kawai, M. (2000). Use of knowledge and heuristics for wayfinding in an artificial environment. *Environment and Behavior*, 32(6):756–774, doi:10.1177/00139160021972784.
- Nakayama, A., Hasebe, K., and Sugiyama, Y. b. u. (2005). Instability of pedestrian flow and phase structure in a two-dimensional optimal velocity model. *Phys. Rev. E*, 71:036121, doi:10.1103/PhysRevE.71.036121.
- Nassar, K. (2011). Sign visibility for pedestrians assessed with agent-based simulation. *Transportation Research Record: Journal of the Transportation Research Board*, 2264:18–26, doi:10.3141/2264-03.
- Nishinari, K., Kirchner, A., Namazi, A., and Schadschneider, A. (2004). Extended floor field ca model for evacuation dynamics. *IEICE Transactions on Information and Systems*, 87(3):726–732.

- Occhialini, M., Bernardini, G., Ferracuti, F., Iarlori, S., D’Orazio, M., and Longhi, S. (2016). Fire exit signs: The use of neurological activity analysis for quantitative evaluations on their perceptiveness in a virtual environment. *Fire Safety Journal*, 82:63–75, doi:10.1016/j.firesaf.2016.03.003.
- O’Keefe, J. (1976). Place units in the hippocampus of the freely moving rat. *Experimental Neurology*, 51(1):78–109, doi:10.1016/0014-4886(76)90055-8.
- Parisi, D. R., Gilman, M., and Moldovan, H. (2009). A modification of the social force model can reproduce experimental data of pedestrian flows in normal conditions. *Physica A: Statistical Mechanics and its Applications*, 388(17):3600 – 3608, doi:https://doi.org/10.1016/j.physa.2009.05.027.
- Peponis, J., Zimring, C., and Choi, Y. K. (1990). Finding the building in wayfinding. *Environment and Behavior*, 22(5):555–590, doi:10.1177/0013916590225001.
- Predtechenskii, V. M. and Milinskii, A. I. (1978). *Planning for Foot Traffic Flow in Buildings*. Amerind Publishing, New Delhi.
- Ranck, J. B. (1985). Head direction cells in the deep cell layer of dorsal presubiculum in freely moving rats. In G. Buzsáki & C.H. Vanderwolf, editor, *Electrical Activity of the Archicortex*, pages 217–220.
- Reuters (24.09.2015). Massenandrang bei Mekka. URL: <http://www.spiegel.de/panorama/mekka-saudi-arabien-hundert-tote-bei-panik-waehrend-hadsch-a-1054504.html>; Retrieved 06.12.2017.
- Schadschneider, A., Klingsch, W., Klüpfel, H., Kretz, T., Rogsch, C., and Seyfried, A. (2009). Evacuation dynamics: Empirical results, modeling and applications. In Meyers, R. A., editor, *Encyclopedia of Complexity and Systems Science*, pages 3142–3176. Springer New York, New York, NY.
- Schäling, B. (2011). *The boost C++ libraries*. XML Press, Laguna Hills, California.
- Schröder, B., Haensel, D., Chraïbi, M., Arnold, L., Seyfried, A., and Andresen, E. (2015). Knowledge- and perception-based route choice modelling in case of fire. In *6th International Symposium on Human Behaviour in Fire 2015*, pages 327–338. Interscience Communications Limited.

## REFERENCES

---

- Seyfried, A., Boltes, M., Kähler, J., Klingsch, W., Portz, A., Rupperecht, T., Schadschneider, A., Steffen, B., and Winkens, A. (2010). Enhanced empirical data for the fundamental diagram and the flow through bottlenecks. In Klingsch, W., editor, *Pedestrian and evacuation dynamics 2008*, pages 145–156. Springer, Berlin and Heidelberg.
- Seyfried, A., Schadschneider, A., Kemloh, U., and Chraïbi, M. (2011). Force-based models of pedestrian dynamics. *Networks and Heterogeneous Media*, 6(3):425–442, doi:10.3934/nhm.2011.6.425.
- Shi, X., Zhirui, Y., Shiwakoti, N., and Li, Z. (2015). A review of experimental studies on complex pedestrian movement behaviors. *Proceedings of CICTP 2015, Beijing, China*.
- Shiwakoti, N., Tay, R., Stasinopoulos, P., and Woolley, P. J. (2016). Passengers awareness and perceptions of way finding tools in a train station. *Safety Science*, 87:179–185, doi:10.1016/j.ssci.2016.04.004.
- Shiwakoti, N., Tay, R., Stasinopoulos, P., and Woolley, P. J. (2017). Likely behaviours of passengers under emergency evacuation in train station. *Safety Science*, 91:40–48, doi:10.1016/j.ssci.2016.07.017.
- Solstad, T., Boccarda, C. N., Kropff, E., Moser, M.-B., and Moser, E. I. (2008). Representation of geometric borders in the entorhinal cortex. *Science (New York, N.Y.)*, 322(5909):1865–1868, doi:10.1126/science.1166466.
- St. Pierre, M. and Hofinger, G. (2014). *Human Factors und Patientensicherheit in der Akutmedizin*. Springer, Berlin [u.a.], 3 edition.
- Stollowsky, C., Schild, G., and Guthke, J. (2010). Tote bei Loveparade in Duisburg. URL: <http://www.tagesspiegel.de/weltspiegel/massenpanik-tote-bei-loveparade-in-duisburg/1890484.html>; Retrieved 06.12.2017.
- Sun, J., Lu, S., Lo, S., Ma, J., and Xie, Q. (2018). Moving characteristics of single file passengers considering the effect of ship trim and heeling. *Physica A: Statistical Mechanics and its Applications*, 490:476–487, doi:10.1016/j.physa.2017.08.031.
- Tan, L., Wu, L., and Lin, H. (2015). An individual cognitive evacuation behaviour model for agent-based simulation: A case study of a large outdoor event. *International Journal of Geographical Information Science*, 29(9):1552–1568, doi:10.1080/13658816.2015.1030751.

- 
- Tang, C.-H., Wu, W.-T., and Lin, C.-Y. (2009). Using virtual reality to determine how emergency signs facilitate way-finding. *Applied ergonomics*, 40(4):722–730, doi:10.1016/j.apergo.2008.06.009.
- Tangient LLC (2017). VRWiki - a Wiki about VR. URL: <https://vrwiki.wikispaces.com/Oculus+Rift+Development+Kit+2>; Retrieved 09.04.2017.
- The CGAL Project (2017). *CGAL User and Reference Manual*. CGAL Editorial Board, 4.11 edition.
- Thompson, P. A. and Marchant, E. W. (1995). A computer model for the evacuation of large building populations. *Fire Safety Journal*, 24(2):131 – 148, doi:[https://doi.org/10.1016/0379-7112\(95\)00019-P](https://doi.org/10.1016/0379-7112(95)00019-P).
- Thorndyke, P. W. and Hayes-Roth, B. (1982). Differences in spatial knowledge acquired from maps and navigation. *Cognitive Psychology*, 14(4):560–589, doi:10.1016/0010-0285(82)90019-6.
- Till, R. C. and Babcock, J. S. (2011). Proof of concept: Use of eye-tracking to record how people use exit signage. In Peacock, R. D., Kuligowski, E. D., and Averill, J. D., editors, *Pedestrian and evacuation dynamics*, pages 209–219. Springer, New York.
- Tolman, E. C. (1948). Cognitive maps in rats and men. *Psychological Review*, 55(4):189–208, doi:10.1037/h0061626.
- Tordeux, A., Chraïbi, M., and Seyfried, A. (2016). Collision-free speed model for pedestrian dynamics. In Knoop, V. L. and Daamen, W., editors, *Traffic and Granular Flow '15*, pages 225–232. Springer International Publishing, Cham.
- Tversky, B. (1993). Cognitive maps, cognitive collages, and spatial mental models. In Goos, G., Hartmanis, J., Frank, A. U., and Campari, I., editors, *Spatial Information Theory A Theoretical Basis for GIS*, volume 716 of *Lecture Notes in Computer Science*, pages 14–24. Springer Berlin Heidelberg, Berlin, Heidelberg.
- Twarogowska, M., Goatin, P., and Duvigneau, R. (2014). Macroscopic modeling and simulations of room evacuation. *Applied Mathematical Modelling*, 38(24):5781–5795.

## REFERENCES

---

- UN DESA (2014). Anteil der in Städten lebenden Bevölkerung in Deutschland und weltweit von 1950 bis 2010 und Prognose bis 2030. URL: <https://de.statista.com/statistik/daten/studie/152879/umfrage/in-staedten-lebende-bevoelkerung-in-deutschland-und-weltweit/>; Retrieved 06.12.2017.
- Vilar, E., Rebelo, F., and Noriega, P. (2014). Indoor human wayfinding performance using vertical and horizontal signage in virtual reality. *Human Factors and Ergonomics in Manufacturing & Service Industries*, 24(6):601–615, doi:10.1002/hfm.20503.
- Vilar, E., Rebelo, F., Noriega, P., Teles, J., and Mayhorn, C. (2013). The influence of environmental features on route selection in an emergency situation. *Applied ergonomics*, 44(4):618–627, doi:10.1016/j.apergo.2012.12.002.
- von Sivers, I., Seitz, M. J., and Köster, G. (2016). How do people search: A modelling perspective. In Wyrzykowski, R., Deelman, E., Dongarra, J., and Karczewski, K., editors, *Parallel Processing and Applied Mathematics*, volume 9574 of *Lecture Notes in Computer Science*, pages 487–496. Springer International Publishing, Cham.
- Wiener, J. M., Büchner, S. J., and Hölscher, C. (2009). Taxonomy of human wayfinding tasks: A knowledge-based approach. *Spatial Cognition & Computation*, 9(2):152–165, doi:10.1080/13875860902906496.
- Wolbers, T. and Hegarty, M. (2010). What determines our navigational abilities? *Trends in cognitive sciences*, 14(3):138–146, doi:10.1016/j.tics.2010.01.001.
- Wong, L. T. and Lo, K. C. (2007). Experimental study on visibility of exit signs in buildings. *Building and Environment*, 42(4):1836–1842, doi:10.1016/j.buildenv.2006.02.011.
- Xiao, Y., Gao, Z., Qu, Y., and Li, X. (2016). A pedestrian flow model considering the impact of local density: Voronoi diagram based heuristics approach. *Transportation Research Part C: Emerging Technologies*, 68:566–580, doi:10.1016/j.trc.2016.05.012.
- Xie, H., Filippidis, L., Galea, E. R., Blackshields, D., and Lawrence, P. J. (2012). Experimental analysis of the effectiveness of emergency signage and its implementation in evacuation simulation. *Fire and Materials*, 36(5-6):367–382, doi:10.1002/fam.1095.



- Xie, H., Filippidis, L., Gwynne, S., Galea, E. R., Blackshields, D., and Lawrence, P. J. (2007). Signage legibility distances as a function of observation angle. *Journal of Fire Protection Engineering*, 17(1):41–64, doi:10.1177/1042391507064025.
- Yu, W. J., Chen, R., Dong, L. Y., and Dai, S. Q. (2005). Centrifugal force model for pedestrian dynamics. *Physical Review E*, 72(2 Pt 2):026112, doi:10.1103/PhysRevE.72.026112.
- Ziemer, V., Seyfried, A., and Schadschneider, A. (2016). Congestion dynamics in pedestrian single-file motion. In Knoop, V. L. and Daamen, W., editors, *Traffic and Granular Flow '15*. Springer International Publishing, Cham.

Band / Volume 26

**UNICORE Summit 2014**

Proceedings, 24<sup>th</sup> June 2014 | Leipzig, Germany

edited by V. Huber, R. Müller-Pfefferkorn, M. Romberg (2014), iii, 60 pp

ISBN: 978-3-95806-004-3

URN: urn:nbn:de:0001-2014111408

Band / Volume 27

**Automatische Erfassung präziser Trajektorien  
in Personenströmen hoher Dichte**

M. Boltes (2015), xii, 308 pp

ISBN: 978-3-95806-025-8

URN: urn:nbn:de:0001-2015011609

Band / Volume 28

**Computational Trends in Solvation and Transport in Liquids**

edited by G. Sutmann, J. Grotendorst, G. Gompper, D. Marx (2015)

ISBN: 978-3-95806-030-2

URN: urn:nbn:de:0001-2015020300

Band / Volume 29

**Computer simulation of pedestrian dynamics at high densities**

C. Eilhardt (2015), viii, 142 pp

ISBN: 978-3-95806-032-6

URN: urn:nbn:de:0001-2015020502

Band / Volume 30

**Efficient Task-Local I/O Operations of Massively Parallel Applications**

W. Frings (2016), xiv, 140 pp

ISBN: 978-3-95806-152-1

URN: urn:nbn:de:0001-2016062000

Band / Volume 31

**A study on buoyancy-driven flows: Using particle image velocimetry  
for validating the Fire Dynamics Simulator**

by A. Meunders (2016), xxi, 150 pp

ISBN: 978-3-95806-173-6

URN: urn:nbn:de:0001-2016091517

Band / Volume 32

**Methoden für die Bemessung der Leistungsfähigkeit  
multidirektional genutzter Fußverkehrsanlagen**

S. Holl (2016), xii, 170 pp

ISBN: 978-3-95806-191-0

URN: urn:nbn:de:0001-2016120103

Band / Volume 33

**JSC Guest Student Programme Proceedings 2016**

edited by I. Kabadshow (2017), iii, 191 pp

ISBN: 978-3-95806-225-2

URN: urn:nbn:de:0001-2017032106

Band / Volume 34

**Multivariate Methods for Life Safety Analysis in Case of Fire**

B. Schröder (2017), x, 222 pp

ISBN: 978-3-95806-254-2

URN: urn:nbn:de:0001-2017081810

Band / Volume 35

**Understanding the formation of wait states in one-sided communication**

M.-A. Hermanns (2018), xiv, 144 pp

ISBN: 978-3-95806-297-9

URN: urn:nbn:de:0001-2018012504

Band / Volume 36

**A multigrid perspective on the parallel full approximation scheme  
in space and time**

D. Moser (2018), vi, 131 pp

ISBN: 978-3-95806-315-0

URN: urn:nbn:de:0001-2018031401

Band / Volume 37

**Analysis of I/O Requirements of Scientific Applications**

S. El Sayed Mohamed (2018), XV, 199 pp

ISBN: 978-3-95806-344-0

URN: urn:nbn:de:0001-2018071801

Band / Volume 38

**Wayfinding and Perception Abilities for Pedestrian Simulations**

E. Andresen (2018), 4, x, 162 pp

ISBN: 978-3-95806-375-4

URN: urn:nbn:de:0001-2018121810

Weitere **Schriften des Verlags im Forschungszentrum Jülich** unter  
<http://www.zb1.fz-juelich.de/verlagextern1/index.asp>



IAS Series  
Band / Volume 38  
ISBN 978-3-95806-375-4